

PROTON FILTRY HYDRAULICZNE

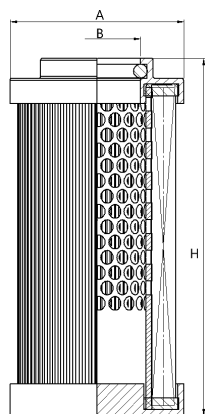

TYP:O-01

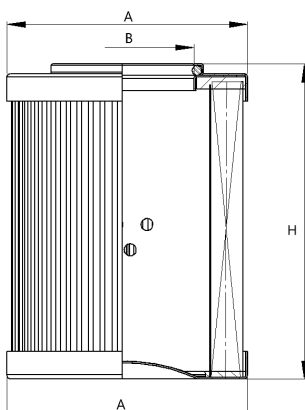

TYP:O-03

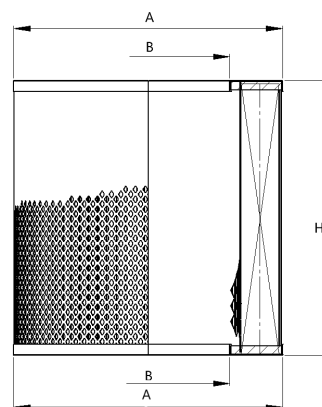

TYP:O-05

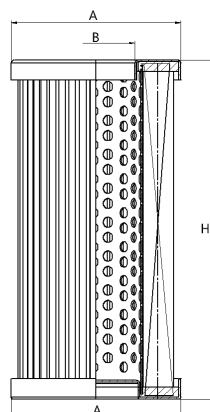

TYP:O-08

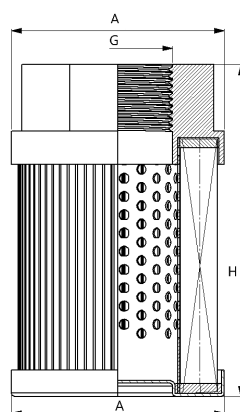

TYP:O-09

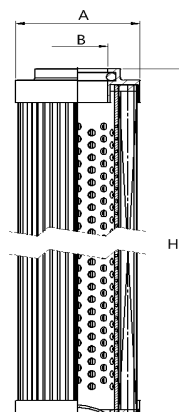

TYP:O-19

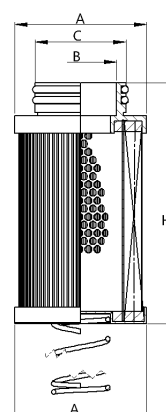

TYP:O-36

	Wymiary [mm]					Uszczelnienie	Typ	Zamiennik
	A	B	H	C	G			
IFO-2473	25	6	42	12	-	-	O-36	
IFO-2208	30	15	26	-	-	-	O-08	
IFO-2306	30	-	68	-	¼"	-	O-09	
IFO-2307	30	15	45	-	-	-	O-08	Demag 10766065
IFO-2239	35	10	33	-	-	-	O-08	
IFO-2390	35	12	94	-	-	NBR	O-03	
IFO-2496	35	11	94	-	-	NBR	O-03	
IFO-2353	39	20	41	-	-	-	O-05	
IFO-2196	40	-	107	-	¾"	-	O-09	
IFO-2337	42	23	90	-	-	NBR	O-03	D75A10CAV
IFO-2336	42	22,8	179	-	-	NBR	O-03	D311G25A
IFO-2421	42	22,8	135	-	-	NBR	O-03	D312G10A.
IFO-2160	43	25	138	-	-	-	O-05	
IFO-2351	43	18,2	53	-	-	NBR	O-03	DVD218B40B
IFO-2019	43,5	23	89	-	-	NBR	O-03	
IFO-2366	44	22	91	-	-	NBR	O-01	D44C10AV, D44C20AV, DHD60A10B
IFO-2078	44,5	22,1	158	-	-	NBR	O-01	XD063G10B
IFO-2142	44,5	22,1	108	-	-	NBR	O-03	DLD60E10B
IFO-2143	44,5	22,1	283	-	-	NBR	O-03	DLD150E10B HY 14083
IFO-2144	44,5	22,1	108	-	-	-	O-03	DLD60E20B
IFO-2186	44,5	22	247	-	-	NBR	O-03	ZD76352
IFO-2409	44,5	22,2	90,5	-	-	NBR	O-03	DHD60B100B
IFO-2225	44,5	21	98	-	-	NBR	O-03	
IFO-2285	44,5	22,1	109	-	-	NBR	O-01	DLD60F20B

Powyzsza oferta ma charakter informacyjny i nie stanowi oferty handlowej w rozumieniu art. 66 §1 Kodeksu Cywilnego

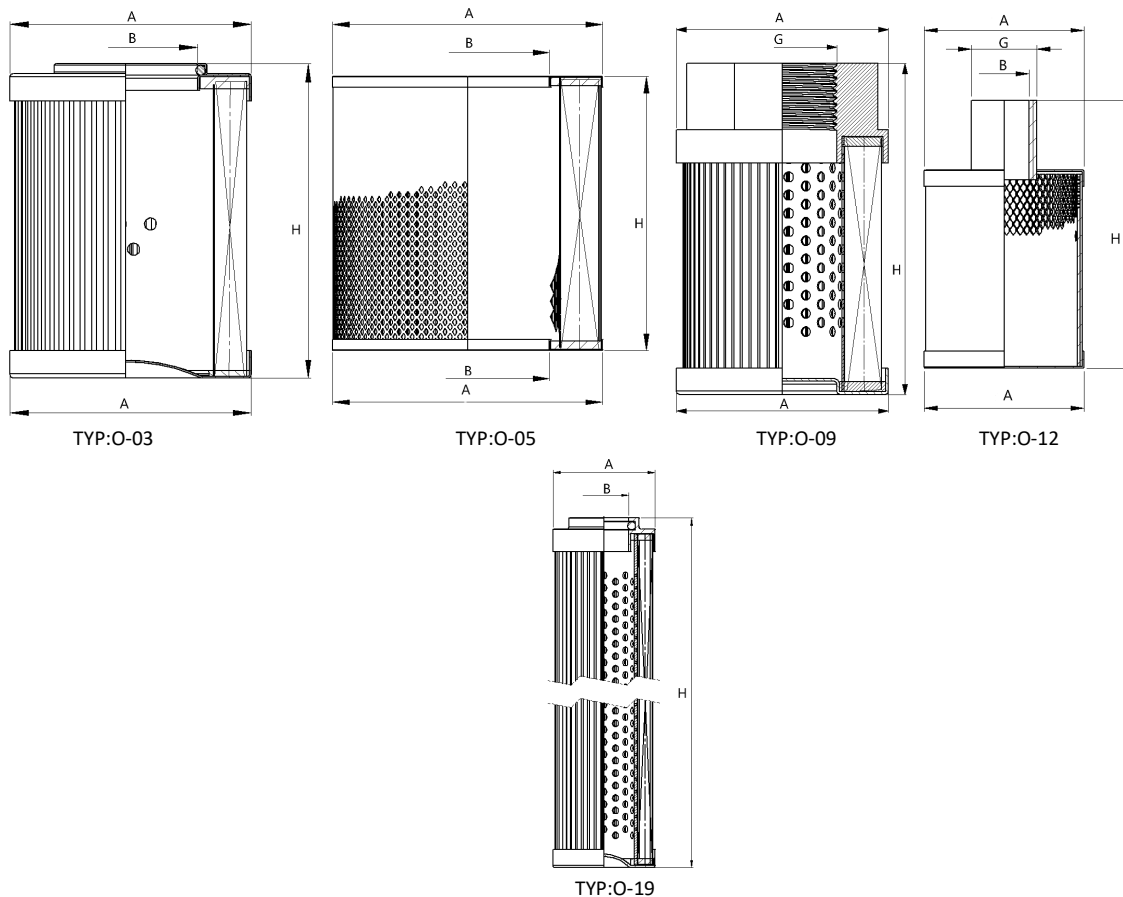

	Wymiary [mm]				Uszczelnienie	Typ	Zamiennik
	A	B	H	G			
IFO-2056	45	22	158	-	NBR	O-03	
IFO-2468	45	25,5	209	-	NBR	O-03	HY18310
IFO-2437	45	24,2	98	-	NBR	O-03	DVD20005B25B
IFO-2092	45	25	94	-	-	O-03	
IFO-2087	45	22	249	-	NBR	O-19	
IFO-2092	45	25	94	-	-	O-03	
IFO-2221	45	15	79	-	NBR	O-03	
IFO-2221	45	15	79	-	NBR	O-03	
IFO-2258	45	25,5	86	-	NBR	O-03	D110T10A, D110G10A
IFO-2260	45	24,2	83	-	-	O-03	DVD20004E10B
IFO-2396	45	22,2	158	-	NBR	O-03	HY15611
IFO-2484	45,5	20,5	199	-	NBR	O-03	
IFO-2500	45,5	20,5	104	-	NBR	O-03	SH 52500
IFO-2284	45,5	14	154,8	-	-	O-12	
IFO-2455	45,8	16,2	30,8	-	-	O-05	
IFO-2081	46	31	100	-	-	O-08	
IFO-2182	46	-	75	3/8"	-	O-09	

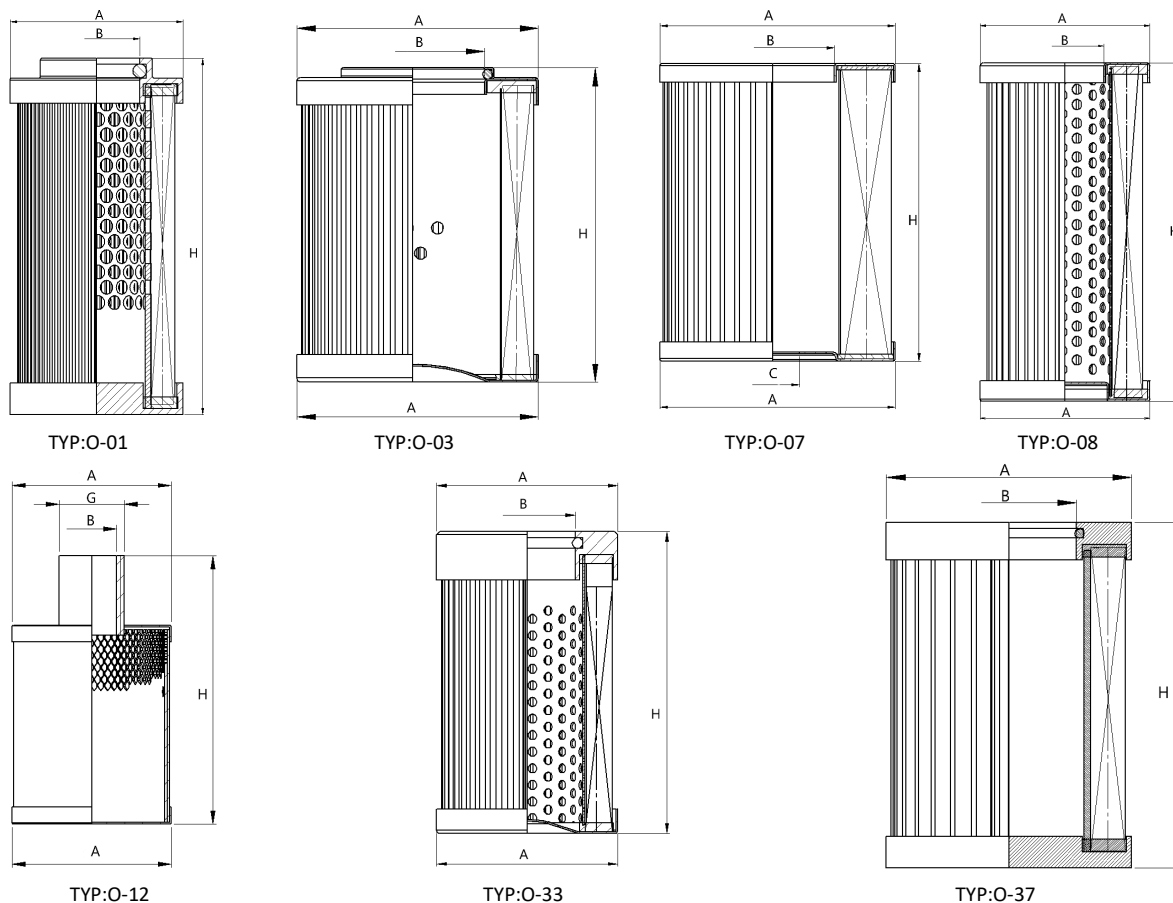

Proton Filters	Wymiary [mm]				Uszczelnienie	Typ	Zamiennik
	A	B	H	C			
IFO-2491	47	22	84	-	NBR	O-01	
IFO-2497	47	22,1	84	-	NBR	O-03	
IFO-2026	47	22	152	-	NBR	O-01	HD 1862 DHD110G10B 0110D010BNHC
IFO-2466	47	22,1	153	-	NBR	O-03	0110D010ON HYDAC
IFO-2027	47	26	221	-	NBR	O-01	HD 4942
IFO-2028	47	22	152	-	NBR	O-03	HYDAC K/ED-A 0110 D 010 BN4HC
IFO-2141	47	25,5	94	-	-	O-08	DMD0005F10B Hydac2.050D25BN
IFO-2242	47	22,2	153	-	NBR	O-03	D70E05GV, DHD110G10B
IFO-2296	47	25,5	172	-	-	O-08	DMD0008E10B, HY15007
IFO-2312	47	22,3	153	-	NBR	O-03	HIFI SH 75012
IFO-2417	47	25	210	-	-	O-08	
IFO-2432	47	25,5	246	-	-	O-08	PI1011MIC25
IFO-2418	47	25	115	-	-	O-08	
IFO-2107	49,5	26,5	121	-	-	O-05	
IFO-2209	49,5	26,5	115	-	-	O-33	
IFO-2270	50	24,5	209	-	NBR	O-03	D121C104
IFO-2428	50	29	152	-	-	O-05	
IFO-2345	50	23	200	-	-	O-08	
IFO-2457	51	27,1	234	-	NBR	O-37	
IFO-2295	51	32	179	-	NBR	O-03	
IFO-2446	51	27,1	234	-	NBR	O-37	
IFO-2097	52	22	200	-	NBR	O-03	HS50011
IFO-2461	52,5	34	171	-	NBR	O-03	
IFO-2253	53	28	229	-	-	O-03	
IFO-2129	53	40	151	2"	-	O-12	
IFO-2346	53	24	159	-	NBR	O-03	P 76-2860 W01AG228
IFO-2407	53	24	330	-	NBR	O-03	

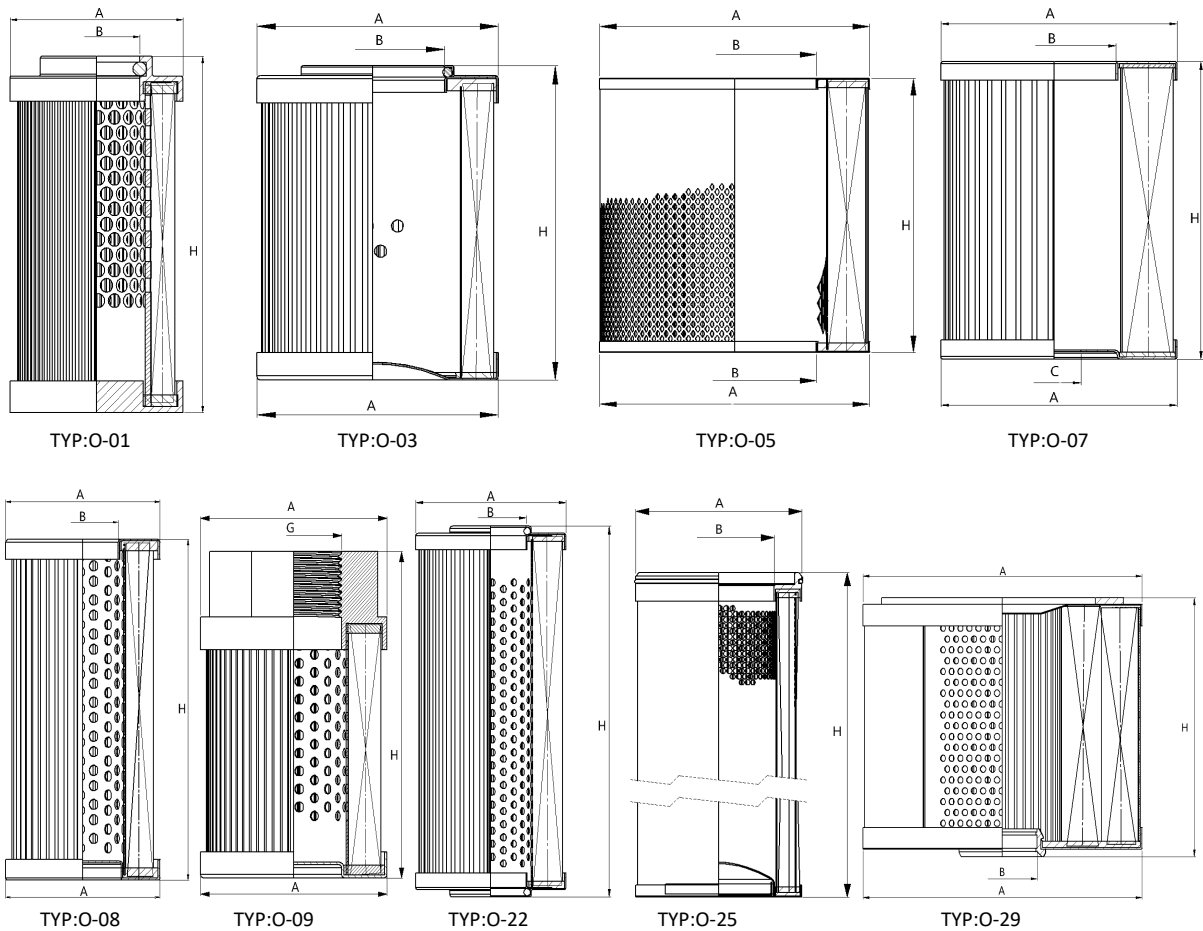

Proton Filters	Wymiary [mm]					Uszczelnienie	Typ	Zamiennik
	A	B	H	C	G			
IFO-2448	53	24,5	209	-	-	NBR	O-03	
IFO-2414	54	32	90	-	-	NBR	O-03	WH50-54.85.10 ZH53-54.85.10A
IFO-2012	54	27,3	222	-	-	NBR	O-03	P171739
IFO-2456	54	14,2	57	-	-	-	O-05	
IFO-2094	54,5	10	61	-	26,5	-	O-07	
IFO-2426	55	34	172	-	-	-	O-05	
IFO-2339	55	26	73	-	-	NBR	O-03	
IFO-2338	56	25	118	-	-	NBR	O-03	W01AG148
IFO-2340	56	31	110,5	-	-	NBR	O-03	WH20-22
IFO-2492	56	24,5	169	-	-	NBR	O-03	SH 75157
IFO-2162	56,5	36	176,5	-	-	-	O-08	
IFO-2066	57	24,5	136	-	-	NBR	O-03	
IFO-2067	57	24,5	145	-	-	-	O-08	
IFO-2083	57	24,5	138,5	-	-	NBR	O-22	
IFO-2192	57	24,5	132	-	-	NBR	O-22	
IFO-2170	58	32	158	-	-	NBR	O-22	SH84126, XR063G25
IFO-2501	58	32,2	180	-	-	NBR	O-29	
IFO-2275	58	49	99	-	-	-	O-07	
IFO-2314	58	30	153	-	-	NBR	O-03	
IFO-2493	58	32,2	249	-	-	NBR	O-22	SH 84140
IFO-2076	59	34,1	173	-	-	NBR	O-01	DHD240H05B
IFO-2169	59	28	232	-	-	NBR	O-05	Arburga WG245
IFO-2222	59	42	155	-	-	-	O-08	
IFO-2279	59	18	139	-	-	-	O-07	WH138510A SH 670104
IFO-2154	60	32	199	-	-	NBR	O-25	InternormenR EATON 310746
IFO-2157	60	-	70	-	3/4"	-	O-09	SF HY 22482F
IFO-2383	60	32	160	-	-	NBR	O-22	EPE : 1.0008P 10 A 000

Powyższa oferta ma charakter informacyjny i nie stanowi oferty handlowej w rozumieniu art. 66 §1 Kodeksu Cywilnego

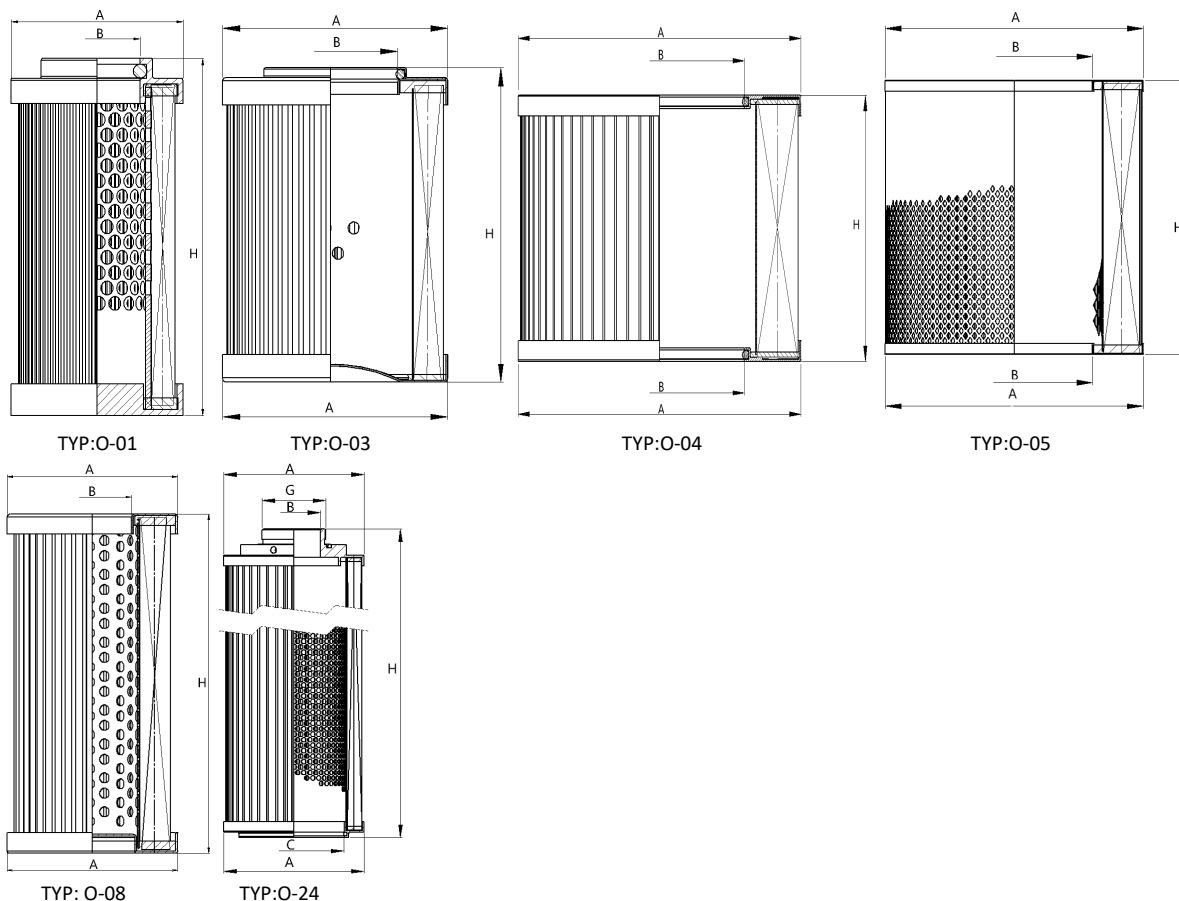

	Wymiary [mm]				Uszczelnienie	Typ	Zamiennik
	A	B	H	G			
IFO-2108	60	24	101	-	-	O-08	
IFO-2454	60	34	160,8	-	-	O-05	
IFO-2480	60	34,2	230	-	NBR	O-01	DLD240T40B 01.E240.40G.HR.E.V.VA
IFO-2485	60	35	230	-	Viton	O-03	HY27315/2
IFO-2505	60	26	83	-	-	O-05	
IFO-2508	60	34	175	-	NBR	O-01	
IFO-2210	60	25,4	768	-	NBR	O-05	
IFO-2449	60	18	100	-	-	O-05	OM-512
IFO-2381	60	34	179	-	NBR	O-03	SH 65077 = D50B10EV
IFO-2413	60	34,2	415	-	VITON	O-01	DLD450T10B
IFO-2443	60	26	194	-	-	O-05	
IFO-2321	60	33	130	-	NBR	O-01	WH50-60.125.10A, OM 581H,
IFO-2181	60	34	187	-	NBR	O-03	SH75068
IFO-2171	60	34	125	-	NBR	O-03	PN40.03.002-A/ES
IFO-2134	60	33	308	-	NBR	O-03	D52B10FV, ZD87766,D52B10EV
IFO-2123	60	33	229	-	NBR	O-03	HIFI SH65089, DLD240E20B,
IFO-2077	60	34,2	186	-	-	O-03	DHD240B25B
IFO-2499	60	29,5	134	-	Viton	O-24	SH 51000
IFO-2039	60	30	113	-	-	O-05	Mann 6230153171
IFO-2207	60	24,3	100	-	-	O-08	
IFO-2286	60	26,5	122	-	-	O-08	
IFO-2393	60	24,3	102,3	-	NBR	O-08	
IFO-2499	60	29,5	134	-	Viton	O-40	

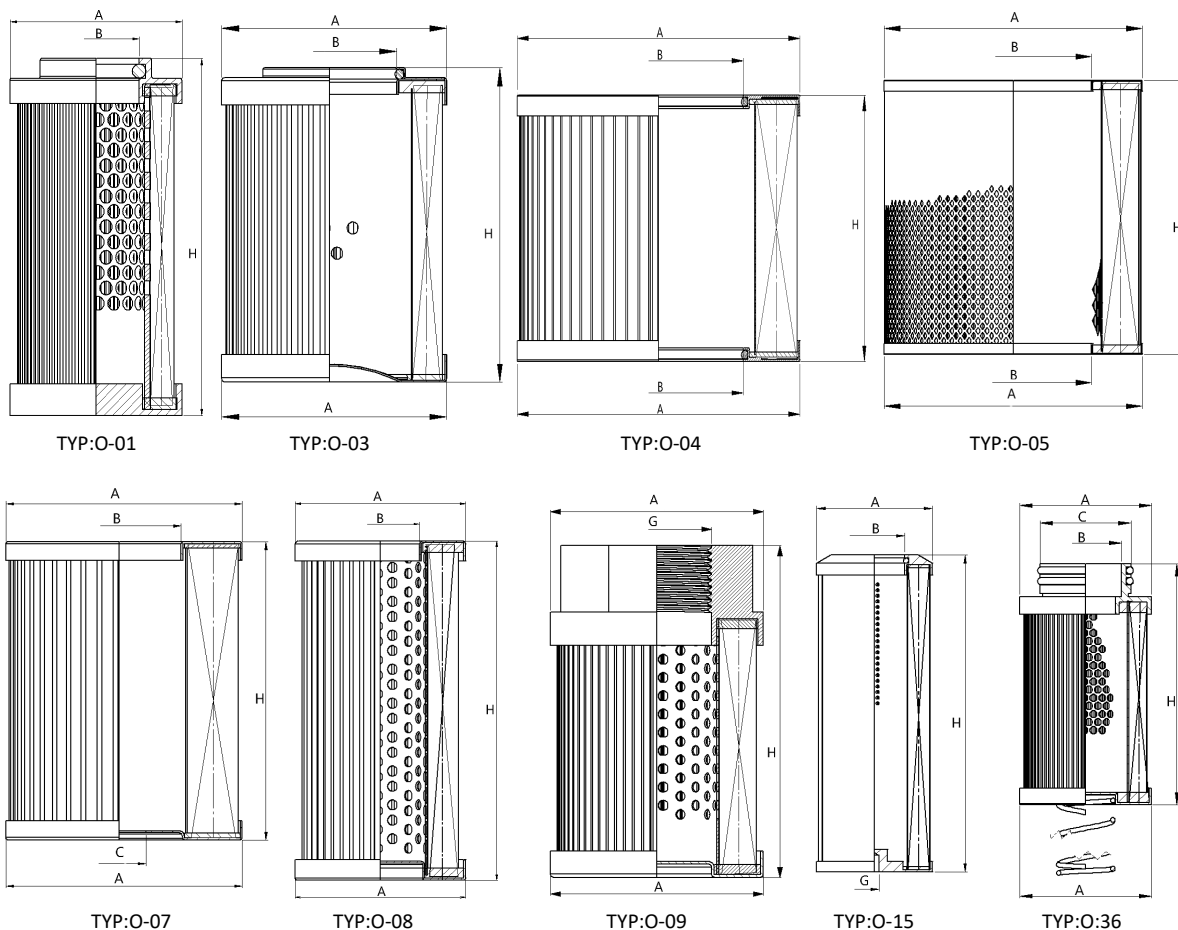

Proton Filters	Wymiary [mm]					Uszczelnienie	Typ	Zamiennik
	A	B	H	G	C			
IFO-2289	60	33	68	10	-	-	O-07	
IFO-2343	60	-	100	M33x2	-	-	O-09	ws2-40s, ZD27957
IFO-2255	61	-	62	1/2"	-	-	O-09	
IFO-2341	61	26	507	-	-	NBR	O-05	
IFO-2016	62	33	153	-	-	NBR	O-03	
IFO-2402	61	26	507	-	-	NBR	O-05	
IFO-2016	62	33	153	-	-	NBR	O-03	
IFO-2323	62	34	84	-	-	NBR	O-01	ZH50-62.84.20
IFO-2069	62,5	32	84	-	-	NBR	O-03	
IFO-2262	62,5	32	79	-	9	NBR	O-07	
IFO-2226	63	28	161	-	-	NBR	O-03	SF HY 90710
IFO-2256	63	33	65,5	-	11	-	O-07	
IFO-2470	63	43	1000	-	-	NBR	O-03	
IFO-2477	63	35	155	-	-	NBR	O-03	
IFO-2276	63	34,5	524	-	37	NBR	O-36	
IFO-2368	63	34,5	356	-	-	NBR	O-36	
IFO-2278	63	38	50	-	10,5	-	O-07	
IFO-2471	63	-	164	Rc 3/4	-	-	O-09	SFN-06-150
IFO-2503	63	-	103	3/4"	-	-	O-09	SH 77251
IFO-2310	63	28,4	213,4	-	28,4	NBR	O-04	GEENS GG001625
IFO-2082	64	-	109	3/4"	-	-	O-09	FS120B4T60
IFO-2272	64	33	154	M10	-	NBR	O-15	P-UH-06.06 10MH
IFO-2460	64	40	300	-	-	-	O-05	
IFO-2148	64,5	27	255	-	-	NBR	O-05	SW10/M150
IFO-2146	64,5	33	128	-	-	NBR	O-03	
IFO-2430	64,5	27	255	-	-	NBR	O-05	SW10/M150

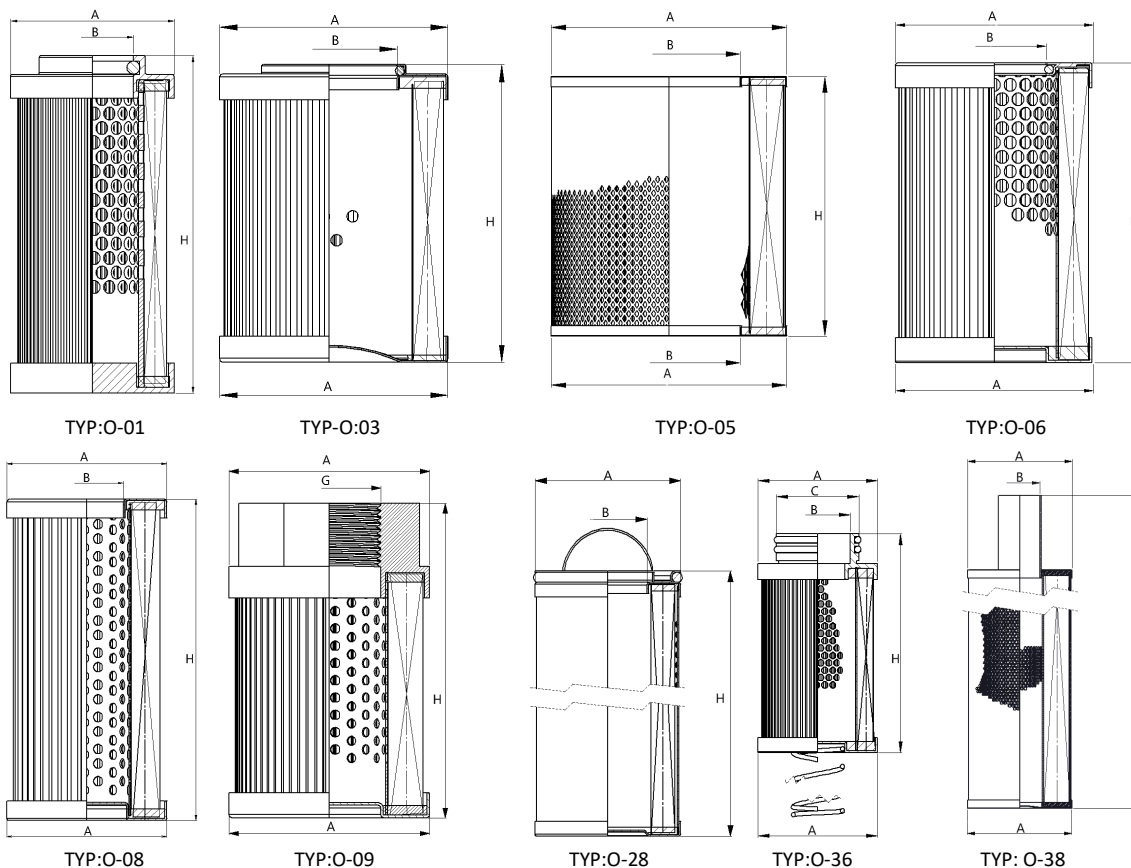

Proton Filters	Wymiary [mm]				Uszczelnienie	Typ	Zamiennik
	A	B	H	G			
IFO-2277	65	20	166	-	-	O-38	WH42-25-25S
IFO-2238	65	18	128	-	NBR	O-28	
IFO-2440	65	26	258	-	NBR	O-05	HY 27312
IFO-2318	66	28	200	-	NBR	O-08	
IFO-2379	66	40	270	-	Viton	O-36	
IFO-2014	66,8	33	114	-	NBR	O-06	
IFO-2427	67	50	180	-	-	O-05	
IFO-2099	69	40,5	43	-	-	O-05	H312100100100
IFO-2125	69	28	120	-	NBR	O-06	WH32-41-100S, WH32-41-100SX
IFO-2145	69	34,2	115	-	NBR	O-03	DHD160G20B
IFO-2180	69	34	173	-	NBR	O-03	SH75182
IFO-2252	69	28	70	-	NBR	O-03	WH32-25-40Sx
IFO-2265	69	34,2	115	-	NBR	O-03	DHD160S200B
IFO-2311	69	34,5	174	-	NBR	O-03	HIFI SH 75038
IFO-2313	69	34,5	115,5	-	NBR	O-03	HIFI SH 75028
IFO-2316	69	34	173	-	NBR	O-01	HIFI SH 75039
IFO-2317	69	34,5	173	-	NBR	O-03	HIFI SH 75036
IFO-2431	69	34,2	355	-	NBR	O-03	
IFO-2331	69	34,2	115	-	VITON	O-01	
IFO-2372	69	34	128	-	NBR	O-03	W01AG412
IFO-2150	69,5	28	49,5	-	NBR	O-06	
IFO-2482	69,5	28,5	85	-	-	O-08	
IFO-2038	70	25	156,5	-	-	O-05	
IFO-2089	70	30	241	-	NBR	O-03	SH75221
IFO-2156	70	33	207	-	NBR	O-03	
IFO-2015	70	26	132	-	-	O-05	
IFO-2237	70	30	160	-	-	O-05	
IFO-2068	70	28	249	-	-	O-05	
IFO-2017	70	-	139	M26x1,5	-	O-09	

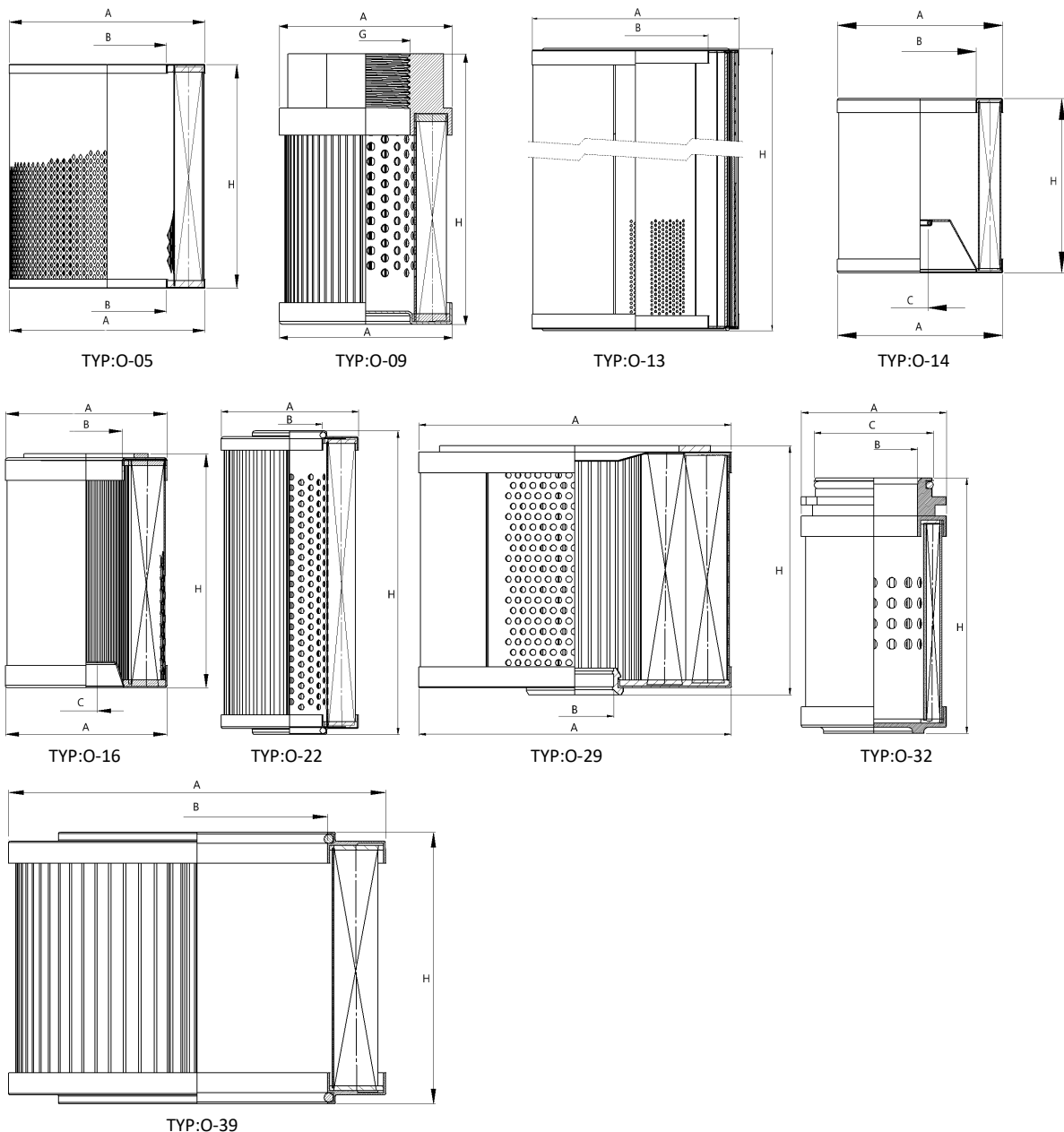

Proton Filters	Wymiary [mm]					Uszczelnienie	Typ	Zamiennik
	A	B	H	G	C			
IFO-2502	70	-	133	-	-	-	O-09	SH 77256
IFO-2044S	70	34	250	-	-	-	O-13	
IFO-2044/1	70	28	250	-	-	-	O-13	
IFO-2088	70	33	156	-	-	NBR	O-22	
IFO-2102S	70	31	372	-	-	-	O-13	
IFO-2178S	70	32	250	-	-	-	O-13	
IFO-2444	70	32	92	-	-	NBR	O-39	
IFO-2382	70	29,5	163	-	-	NBR	O-22	SH 63255
IFO-2178/1S	70	32	130	-	-	-	O-13	
IFO-2185	70	25,8	245	-	-	-	O-13	PSF1001ZMH13
IFO-2137	71	43	757	-	48,5	NBR	O-32	
IFO-2211	71	46	200	-	8	NBR	O-14	
IFO-2261	71	45	400	-	8	-	O-16	Parker FC1250
IFO-2355	71	39	108	-	-	NBR	O-29	
IFO-2021	72	-	192	1 ¼"	-	-	O-09	0660D050WHC
IFO-2098	72	28	130	-	-	-	O-05	HS50012

Powyższa oferta ma charakter informacyjny i nie stanowi oferty handlowej w rozumieniu art. 66 §1 Kodeksu Cywilnego

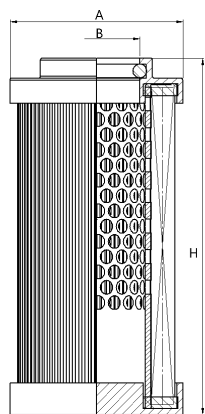

TYP:O-01

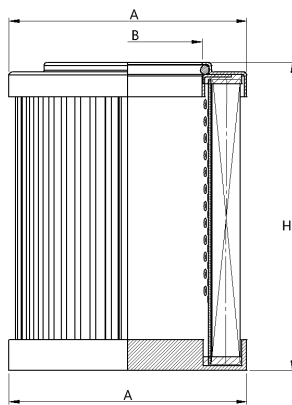

TYP:O-02

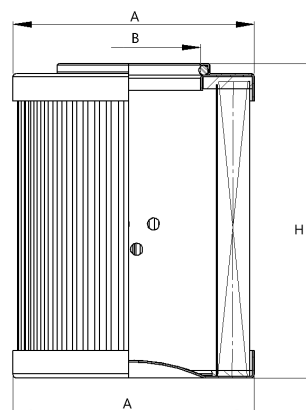

TYP:O-03

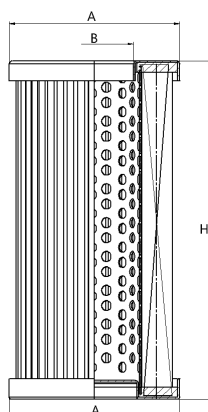

TYP:O-08

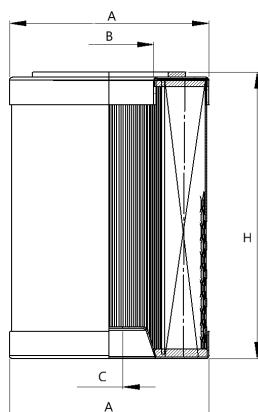

TYP:O-16

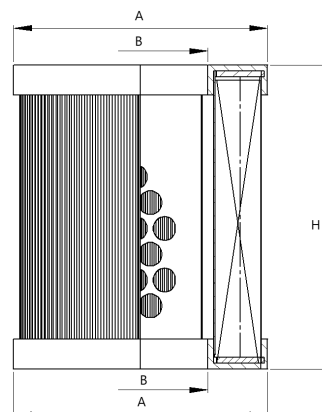

TYP:O-17

Proton Filters	Wymiary [mm]				Uszczelnienie	TYP	Zamiennik
	A	B	H	C			
IFO-2103	72	42	183	-	-	O-17	
IFO-2085	72,5	32,5	157	10	-	O-16	
IFO-2298	73	32	180	-	NBR	O-03	Mann HD 820
IFO-2395	74	46	222	-	-	O-08	
IFO-2071	74	33	105	-	NBR	O-03	
IFO-2494	74	40,3	376	-	NBR	O-03	SH 67134
IFO-2410	74	40,3	275	-	NBR	O-03	DVD2360E20B
IFO-2046	75	45	169	-	-	O-08	WO82-75.169.40
IFO-2100	76	71	325	-	-	O-03	
IFO-2074	77	48	181	-	NBR	O-01	D41B05FV
IFO-2288	77	48,2	179	-	NBR	O-02	DHD330B100B WH52-77.175.40
IFO-2465	77	48,2	346	-	NBR	O-03	
IFO-2424	77	48	495	-	NBR	O-01	01.E900.130G.30.E.P
IFO-2365	77	48,2	350,5	-	NBR	O-02	
IFO-2406	77	30	172	-	NBR	O-08	
IFO-2478	77	48,2	179	-	NBR	O-03	HY13107
IFO-2118	78	40	247	-	NBR	O-03	HIFI SH65424 XD250T25A
IFO-2138	78	40,5	155,6	-	NBR	O-03	
IFO-2138	78	40,5	157	-	NBR	O-03	
IFO-2205	78	43	209	-	NBR	O-03	D52A25TAV
IFO-2216	78	43	210	-	NBR	O-03	
IFO-2227	78	40,5	238	-	NBR	O-03	D151G10A
IFO-2232	78	43,2	261	-	VITON	O-03	
IFO-2325	78	40,5	235	-	NBR	O-03	D151T25A MP FILTRI HP3202M25AN
IFO-2336	78	40	170	-	NBR	O-03	D10A25GAV
IFO-2344	78	43,2	428	-	NBR	O-03	D143G03A
IFO-2352	78	40,2	398	-	NBR	O-01	

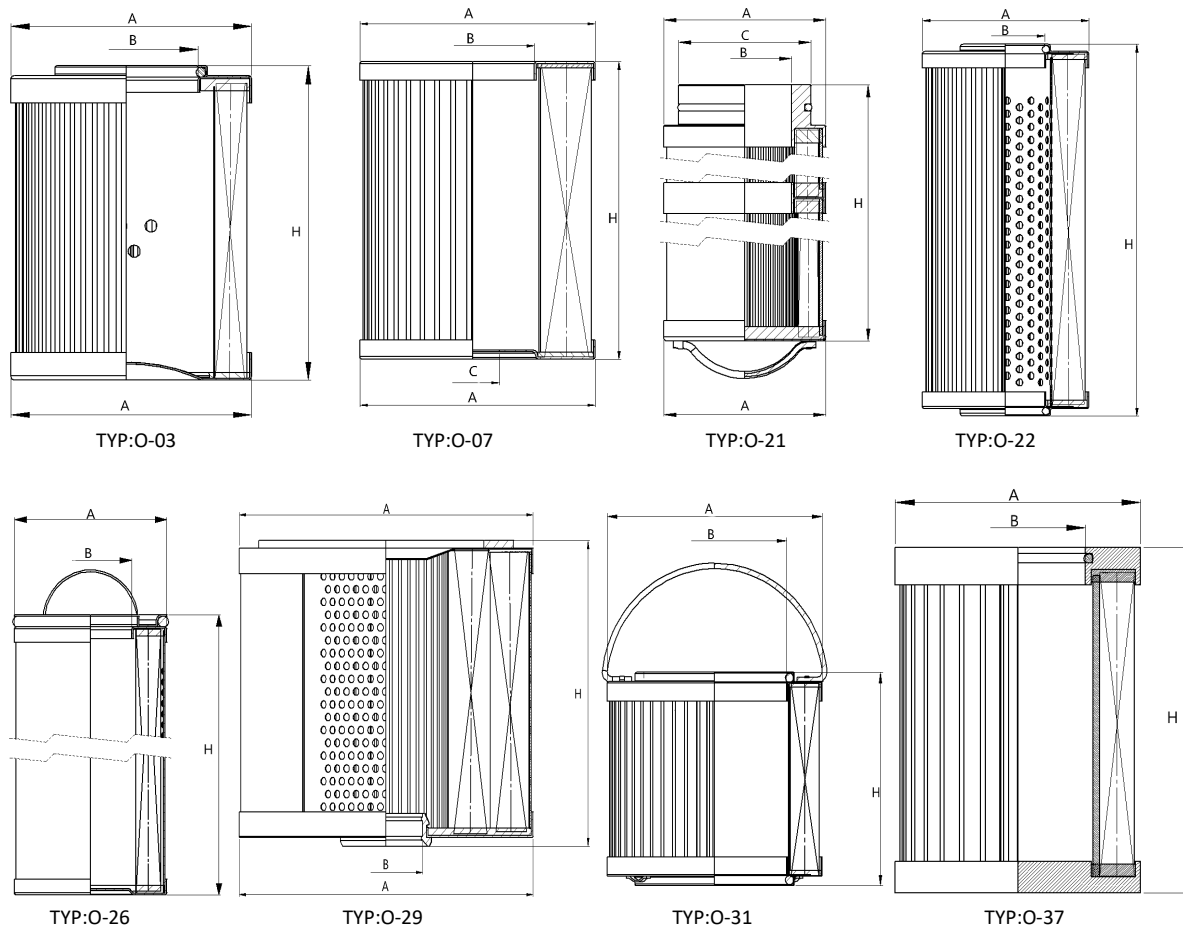

Proton Filters	Wymiary [mm]				Uszczelnienie	Typ	Zamiennik
	A	B	H	C			
IFO-2347	78	41	375	-	NBR	O-03	P171747 D57A10GAV
IFO-2487	78	40,5	333	-	NBR	O-03	D842G10A D12A10GAV
IFO-2490	78	43,2	329	-	NBR	O-03	
IFO-2348	78	41	397	-	NBR	O-03	307254 D60E25TAV, XD400G25A
IFO-2498	78	42,5	330	-	NBR	O-03	SH 57125, P164176
IFO-2370	78	40	381	-	NBR	O-03	
IFO-2380	78	40,5	248	-	NBR	O-03	0250 DN 200 W/HC , XD250T100A
IFO-2483	78	40,5	232	-	NBR	O-03	D841G10A /SH 52806
IFO-2095	78	42	246	-	NBR	O-26	
IFO-2276	78	43	210	-	NBR	O-37	HC 9601 FDP 8H, D141G03B
IFO-2240	78	43	118	-	VITON	O-37	D140G10B
IFO-2274	78	71,5	119	58	-	O-07	
IFO-2352/1	78	40,2	398	-	NBR	O-29	
IFO-2467	78	43	430	-	NBR	O-37	D143G06B
IFO-2376	78	43	210	-	NBR	O-37	HC 9601 FDP 8H, D141G03B
IFO-2475	78	39,5	239	-	NBR	O-03	
IFO-2392	78,5	44	327	-	NBR	O-03	
IFO-2023	79	44	338	-	NBR	O-22	
IFO-2024	79	44	202	-	NBR	O-03	G/D 89515869 F1324
IFO-2036	79	45	202	-	NBR	O-03	
IFO-2117	79	45	324	-	NBR	O-03	S-148204 EICKHOFF
IFO-2359	79	44	208	-	NBR	O-03	
IFO-2266	79	46	1043	64,5	NBR	O-21	
IFO-2315	79	44	330	-	NBR	O-31	
IFO-2217	79	43	114,5	-	VITON	O-37	S-148204 EICKHOFF
IFO-2375	80	42,5	249,5	-	NBR	O-03	DVD20030B40B
IFO-2488	80	44	114	-	NBR	O-03	SH 57117

Powyższa oferta ma charakter informacyjny i nie stanowi oferty handlowej w rozumieniu art. 66 §1 Kodeksu Cywilnego

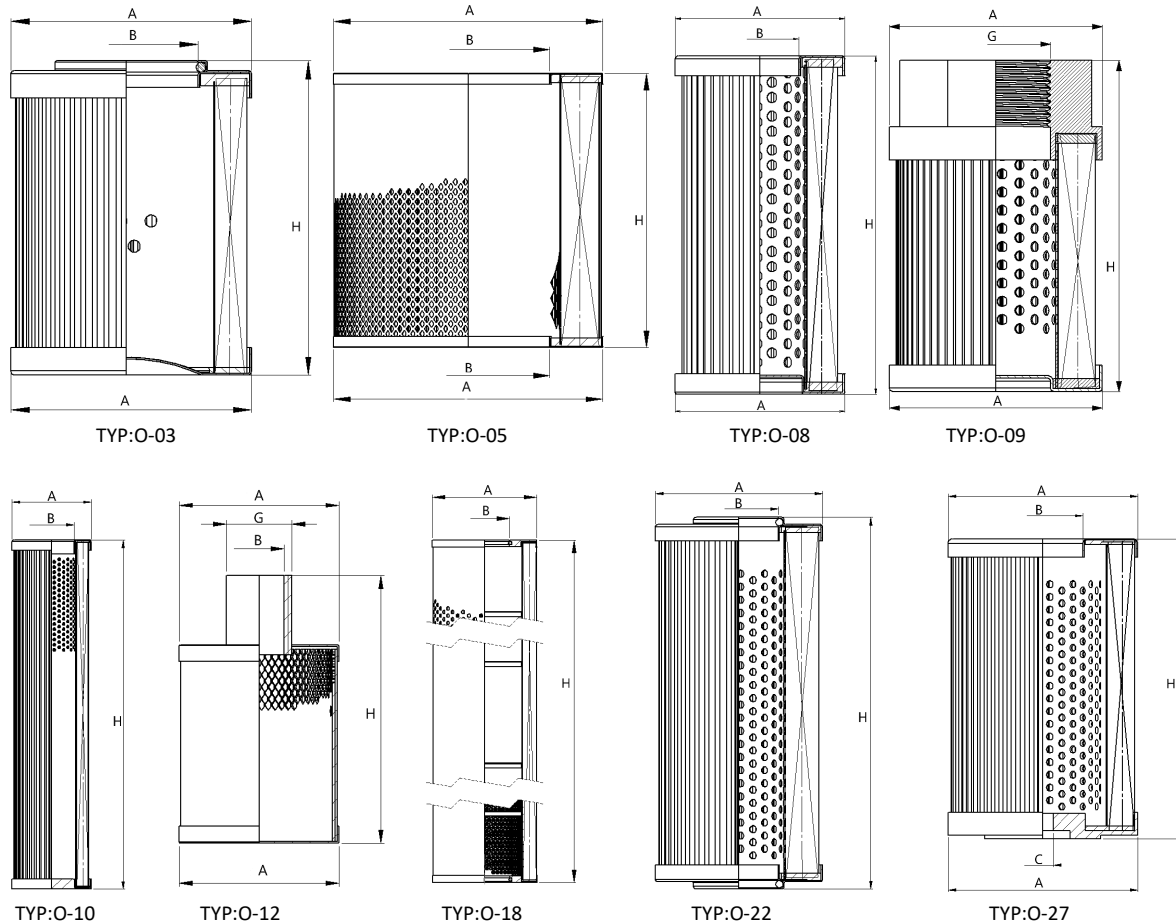

Proton Filters	Wymiary [mm]					Uszczelnienie	TYP	Zamiennik
	A	B	H	G	C			
IFO-2035	80	-	140	1"	-	-	O-09	
IFO-2384	80	-	218	3/4"-14	-	-	O-09	
IFO-2161	80	40	400	-	-	NBR	O-03	Rexroth: R928008800
IFO-2188	80	42,5	158	-	-	NBR	O-03	Hennecke D9550-119 010
IFO-2287	80	-	435	1"	-	-	O-12	
IFO-2291	80	42,2	249	-	-	NBR	O-22	RVR10018E20B
IFO-2308	80	40	171	-	-	NBR	O-03	Demag 10766065
IFO-2364	80	42	397	-	-	NBR	O-03	DVD20045B100B
IFO-2320	80	42	357	-	-	NBR	O-05	
IFO-2375	80	42,5	248	-	-	NBR	O-03	DVD20030B40B
IFO-2267	81	41,4	235	-	-	NBR	O-18	ARGO HYTOS S2.0920-15
IFO-2124	81	40	200	-	-	NBR	O-05	D650G06BV
IFO-2060	82	46	203	-	-	NBR	O-03	P-G-UL-12A-50UW
IFO-2301	82	44	204,5	-	-	NBR	O-03	
IFO-2096	82	35	130	-	10,5	-	O-27	
IFO-2001	83	47,4	142	-	-	-	O-08	MF61002
IFO-2003	83	47,4	256	-	-	-	O-08	DMD0030E10B, DMD0030B25B MAHLE P18430 DRG 60
IFO-2004	83	47,4	371	-	-	-	O-08	MAHLE P18445 DRG 60
IFO-2007	83	47,4	371	-	-	-	O-08	
IFO-2327	83	47,4	199	-	-	-	O-05	
IFO-2133	83	47,4	194	-	-	-	O-05	
IFO-2243	83	47,4	150	-	-	-	O-03	ML YL-195-100 B2010120443
IFO-2003	83	47,4	256	-	-	-	O-10	MAHLE P18430 DRG 60 SH 84052 DMD0030B25B
IFO-2004	83	47,4	371	-	-	-	O-10	MAHLE P18445 DRG 60
IFO-2175	83	47,4	258	-	-	-	O-10	

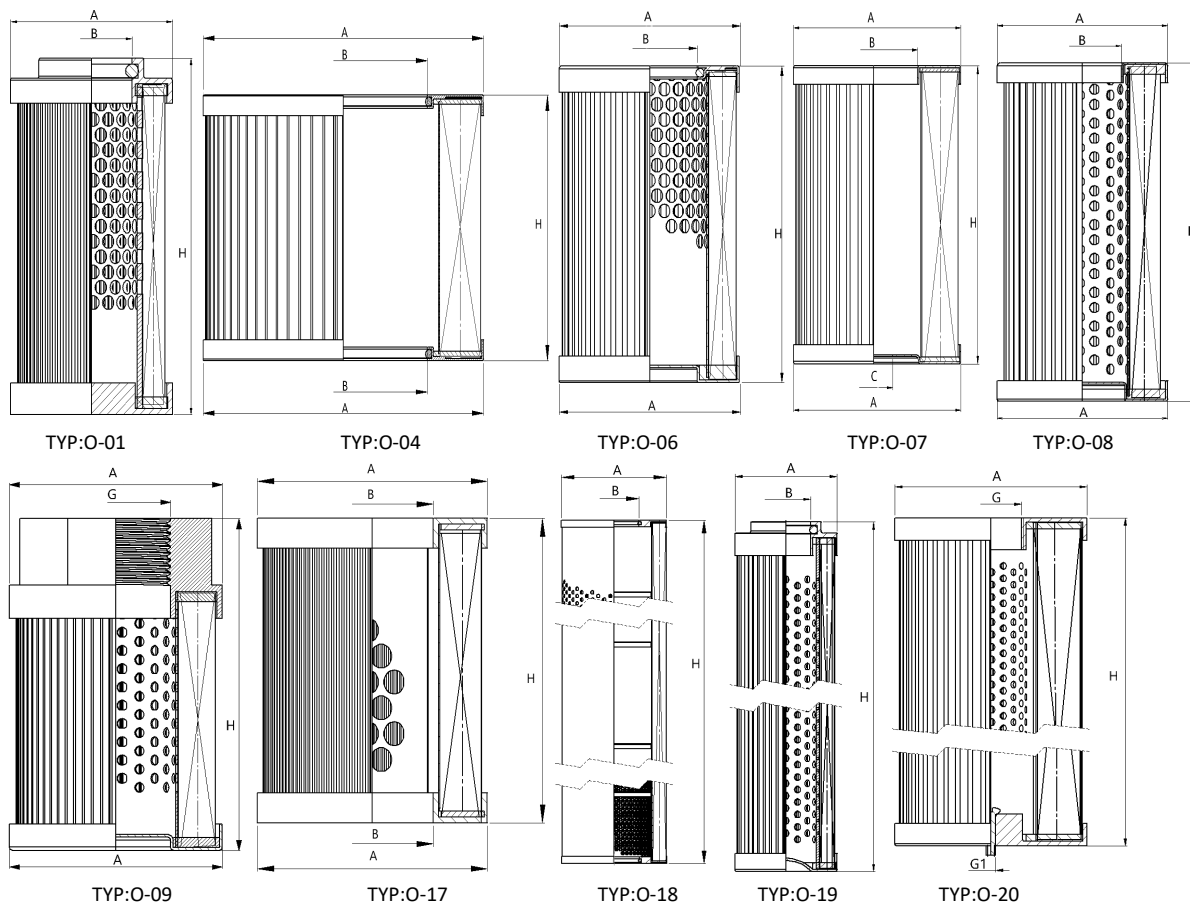

Proton	Wymiary [mm]					Uszczelnienie	TYP	Zamiennik
	A	B	H	G	G1			
IFO-2011	83	47,4	141,5	-	-	-	O-08	MAHLE PI8215 DRG 25
IFO-2472	83	-	209	RC1	-	-	O-09	
IFO-2233	83	47,4	127	-	-	-	NBR	SH61102
IFO-2070	84	41	99,5	-	-	18	O-07	
IFO-2064	85	-	205	M27x1,5	M4	-	O-20	
IFO-2084	85	45	282	-	-	-	O-17	
IFO-2271	85	-	196	1 1/2"	-	-	O-09	
IFO-2459	86	-	260	2"	-	-	O-09	
IFO-2419	86	52,5	385	-	-	-	NBR	
IFO-2172	87	46,5	140	-	-	-	NBR	
IFO-2244	87	-	210	M25x1,5	M4	-	O-20	
IFO-2112	88	42	553	-	-	-	NBR	O-04
IFO-2411	88	44,5	320,5	-	-	-	NBR	O-01
IFO-2113	88	44	560	-	-	-	NBR	O-04
IFO-2149	90	40	160	-	-	-	NBR	O-06
IFO-2155	90	40	160	-	-	-	NBR	O-06
								WH32-101-25SX, WH32-101-100SX, WH32-101-140SX, WH32-101-140SX
IFO-2042	90	32	68	-	-	-	O-08	
IFO-2075	90	48	162	-	-	-	NBR	O-01
IFO-2495	90	48	162	-	-	-	NBR	O-01
								D41B05HV DHD330H10B

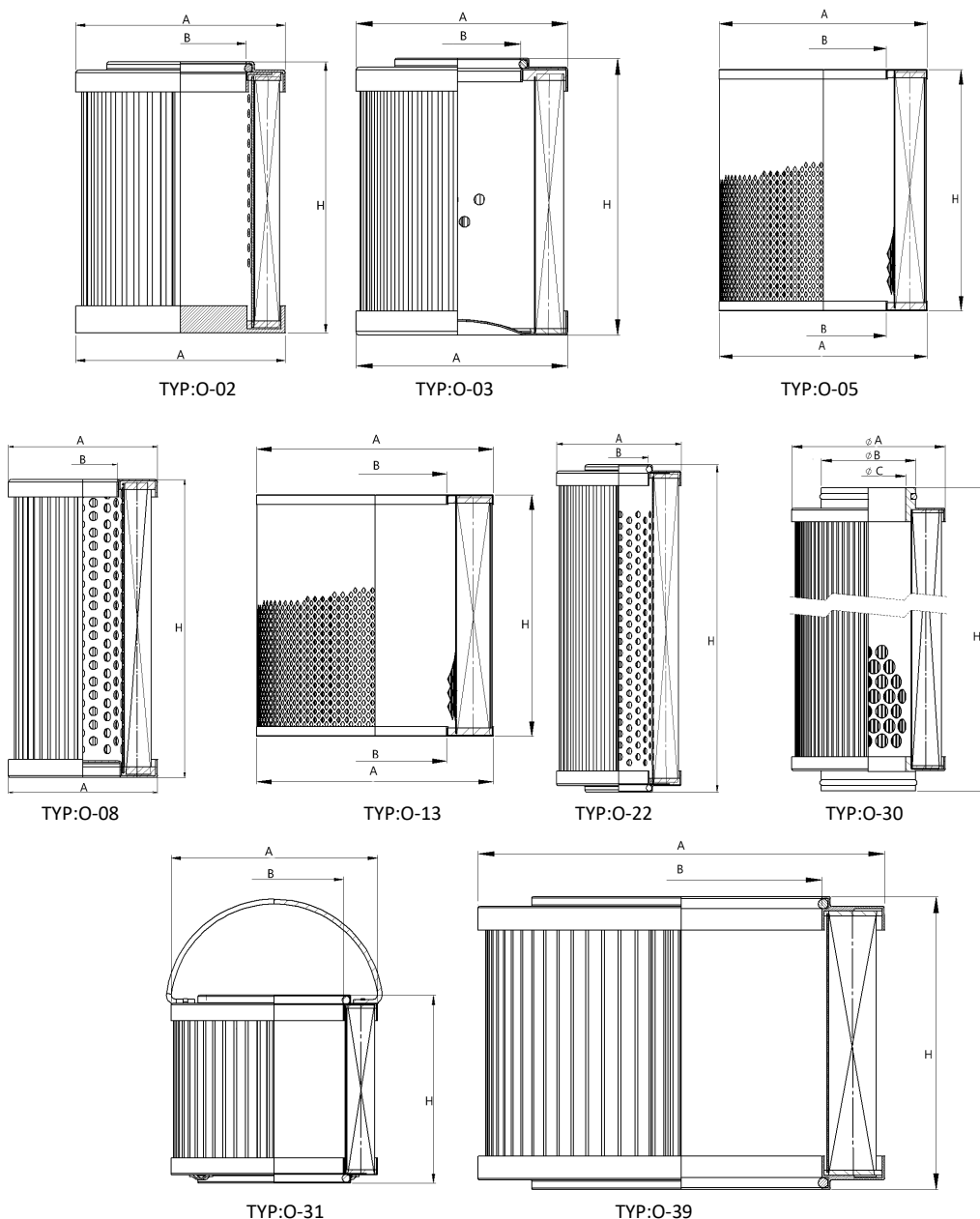

Proton Filters	Wymiary w [mm]				Uszczelnienie	Typ	Zamiennik
	A	B	H	C			
IFO-2462	90	28	178	-	NBR	O-30	
IFO-2212	90	37	246	-	NBR	O-22	
IFO-2213	90	44	274	13	NBR	O-30	
IFO-2303	90	62	42	-	NBR	O-05	
IFO-2020	90,5	48	330	-	NBR	O-03	D45B05HV
IFO-2020/1	90,5	48	328	-	NBR	O-02	DHD660W50V
IFO-2489	90,5	48,2	162	-	NBR	O-03	SH 75044 DHD330G10B
IFO-2041	90,5	48	249	-	NBR	O-02	FILTREC DHD500H038
IFO-2371	90,5	47,5	163	-	NBR	O-03	
IFO-2037	91	48	223	-	NBR	O-05	MFE -3600-S3L2-10 parker QA-L3413
IFO-2204S	92	62	306	-	-	O-13	
IFO-2412	92	62	327,5	-	-	O-05	
IFO-2223	92	62	303	-	-	O-13	
IFO-2513S	92	62	330	-	-	O-13	
IFO-2428	94	49	525	-	NBR	O-39	
IFO-2194	95	44	270	-	-	O-31	

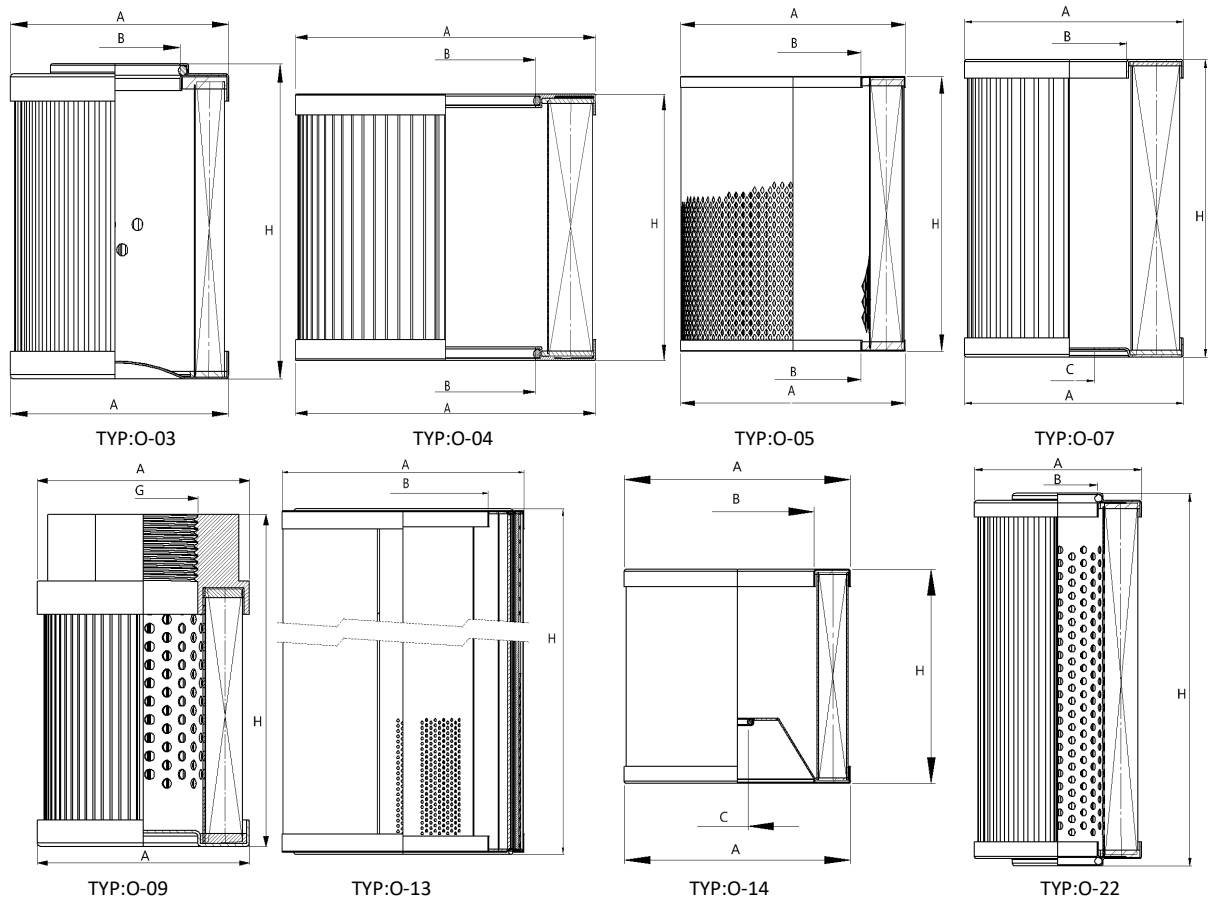

Proton	Wymiary [mm]					Uszczelnienie	Typ	Zamiennik
	A	B	H	C	G			
IFO-2281	95	43	200	-	-	-	O-05	M5402MK
IFO-2506	95	28,5	103	-	-	-	O-05	
IFO-2425	95	47	175	16	-	NBR	O-07	
IFO-2474	95	56	324	-	-	NBR	O-22	PALL HC9400FUT13H P164225
IFO-2273	96	55,5	920	-	-	NBR	O-03	
IFO-2349	96	56	653	-	-	NBR	O-03	D615G25, HC8900FKT26H, D87A25GV
IFO-2090	98	40	360	-	-	NBR	O-05	HS50009
IFO-2091	98	40	334	-	-	NBR	O-05	HS50010
IFO-2214	99	52	19	12	-	VITON	O-14	
IFO-2229	99	52	210	-	-	NBR	O-22	R241T25 Filtrac / CU250M25 MP
IFO-2333	99	41	173	15	-	NBR	O-07	D240T60
IFO-2309	99	53	248,5	-	-	NBR	O-04	HIFI SH 84115
IFO-2441	99	63	218	12	-	NBR	O-13	
IFO-2400	99	52	423	-	-	NBR	O-22	R242T60 HY18165
IFO-2354	99,5	48	126	18,5	-	-	O-07	
IFO-2269	100	52,5	160	-	-	NBR	O-04	XR160G10
IFO-2048	100	-	220	-	2"	-	O-09	
IFO-2153	100	-	56	-	½"	-	O-09	
IFO-2164	100	-	120	-	1 ½"	-	O-09	
IFO-2165	100	-	250	-	1 ½"	-	O-09	
IFO-2299	100	60	234	-	-	NBR	O-22	1361G200AOV0T
IFO-2453	100	60,2	399	-	-	58x3,5	O-03	HY14347
IFO-2459	100	-	183	-	1 ½"	-	O-09	HY10284
IFO-2481	100	60	230	-	-	NBR	O-05	

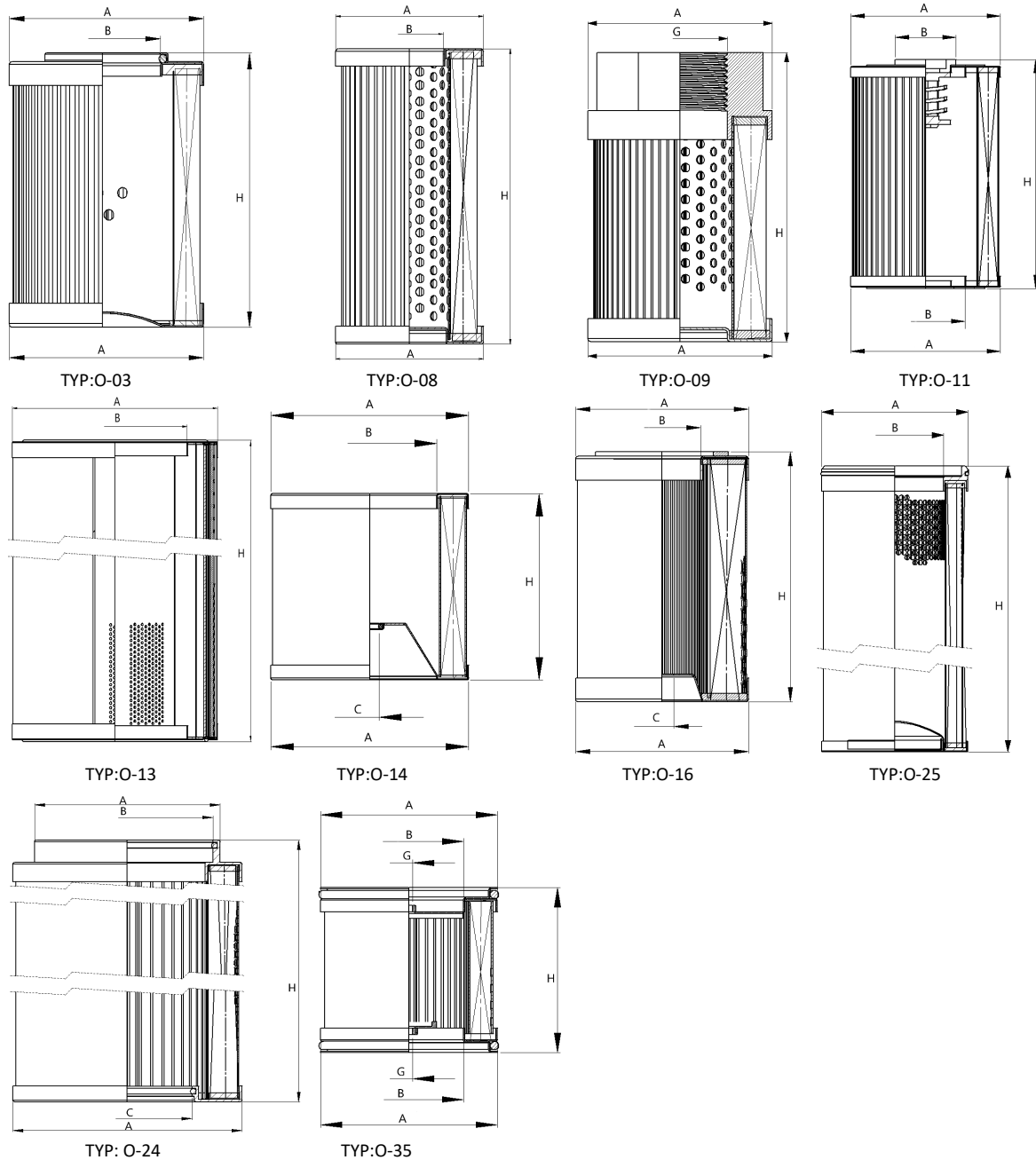

Proton Filters	Wymiary [mm]					Uszczelnienie	Typ	Zamiennik
	A	B	H	G	C			
IFO-2177	100,5	62	600	-	-	NBR	O-35	
IFO-2131	101	52	574	-	-	NBR	O-25	
IFO-2151	101	39,5	100,5	-	-	NBR	O-08	
IFO-2152	101	39,5	101	-	-	NBR	O-08	
IFO-2174	102	-	482	M6	-	NBR	O-35	
IFO-2218	103	40,5	582	-	-	VITON	O-03	
IFO-2394	103	62,5	179	-	-	-	O-11	
IFO-2445	103	54	440	-	72	NBR	O-24	
IFO-2219	104	-	87	1 ¼"	-	-	O-09	
IFO-2510	104	-	230	1 ¼"	-	-	O-09	
IFO-2385	105	93,4	295	-	-	-	O-08	
IFO-2114	106	72	464	-	10	NBR	O-16	
IFO-2377S	106	82	262	-	-	NBR	O-16	3952-6451-020
IFO-2187S	106	58	84	-	-	-	O-13	
IFO-2247	106	72	520	-	10	NBR	O-14	

Powyższa oferta ma charakter informacyjny i nie stanowi oferty handlowej w rozumieniu art. 66 §1 Kodeksu Cywilnego

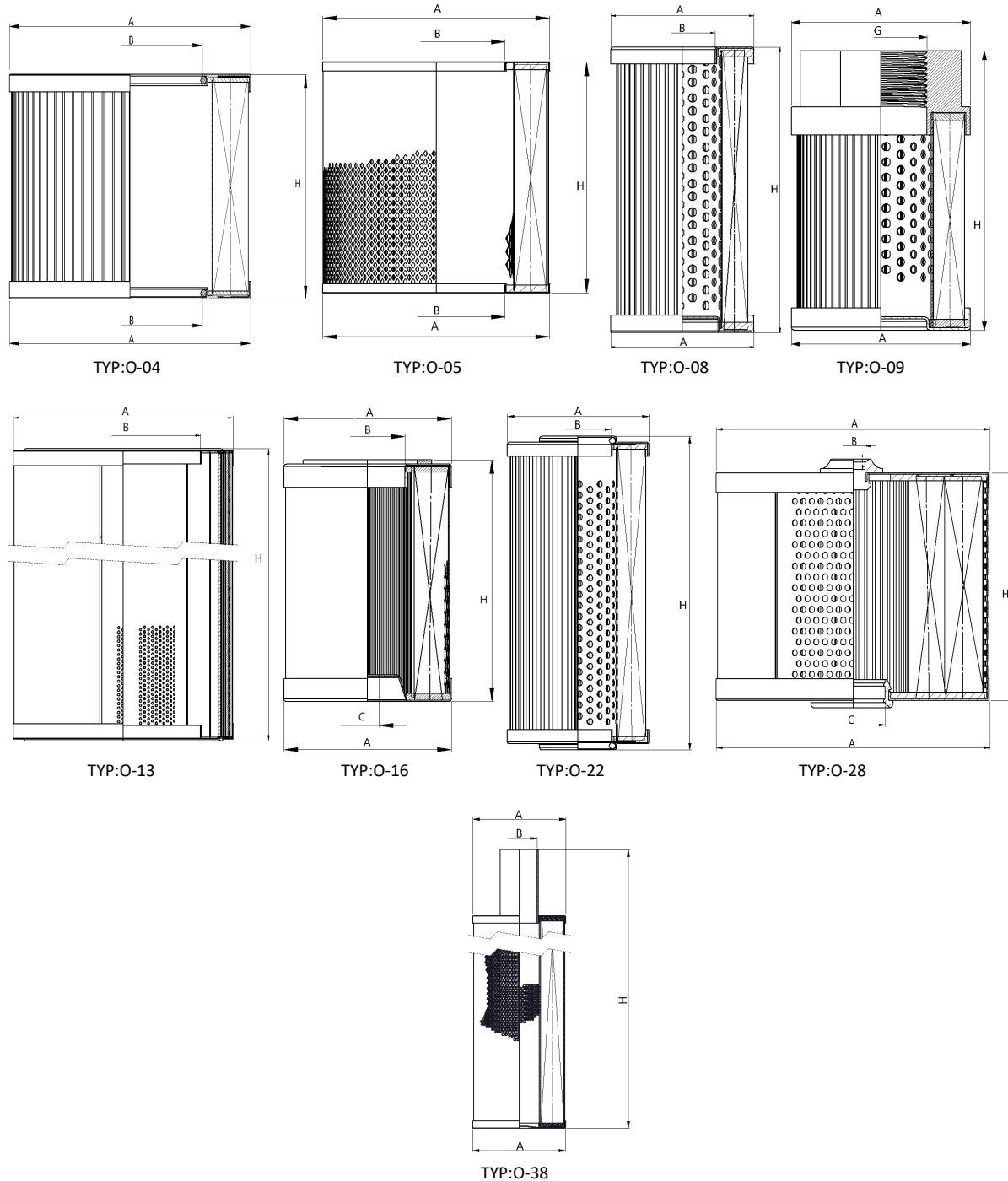

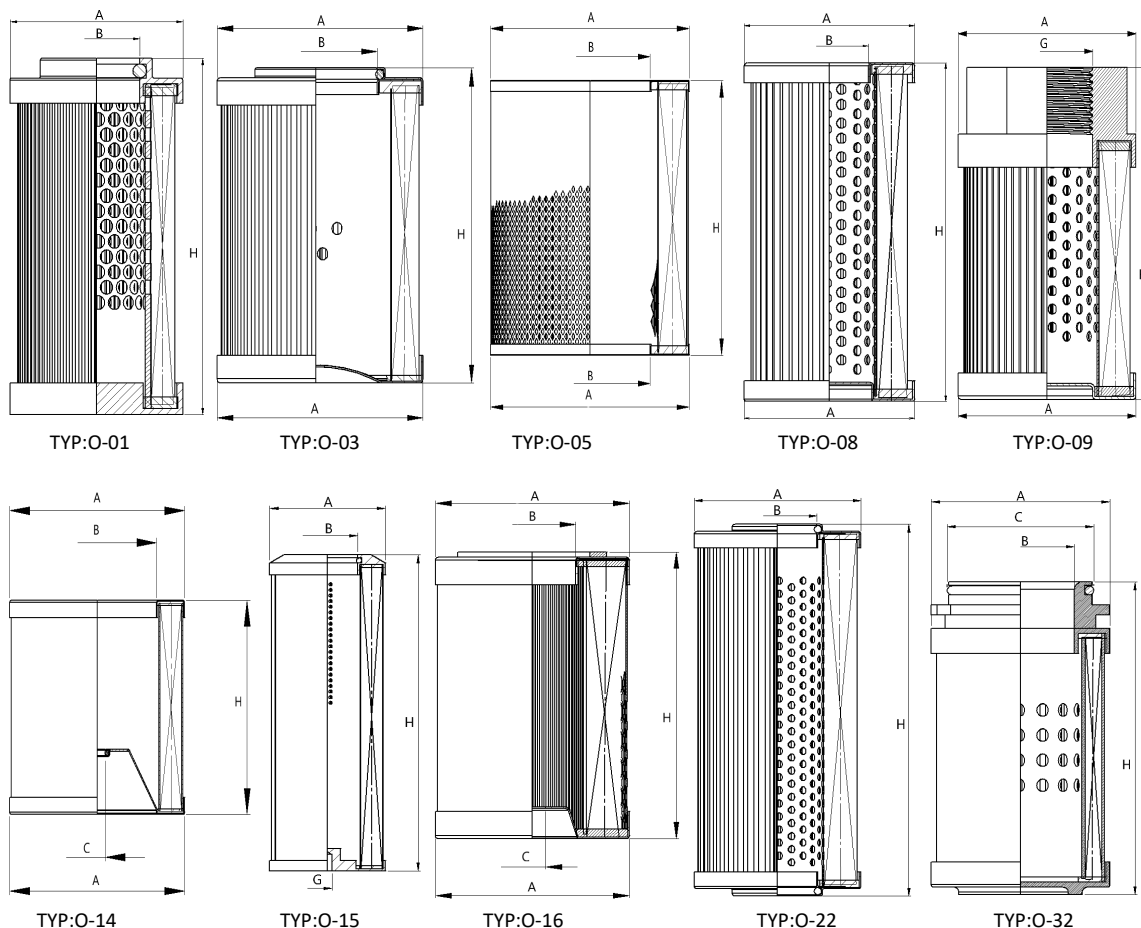

	Wymiary [mm]					Uszczelnienie	Typ	Zamiennik
	A	B	H	G	C			
IFO-2022	108	-	215	2''	-	-	O-09	
IFO-2198	108	-	240	2''	-	-	O-09	
IFO-2065	109	56	149	-	-	NBR	O-04	
IFO-2121	110	36,5	112	-	-	NBR	O-28	
IFO-2132	110	62	200	-	-	-	O-05	WIX R57F20G
IFO-2166	110	55	157	-	-	NBR	O-22	D-68775 ketsch, 10020 G200-A00-0-V
IFO-2245	110	55	248	-	-	NBR	O-22	RVR10030E10B
IFO-2300	110	55,5	400	-	-	NBR	O-22	
IFO-2254	110	24,5	115	-	-	NBR	O-28	
IFO-2294	110	62	382	-	-	-	O-08	ZD24810
IFO-2386	110	42	498	-	-	-	O-38	ZD07426 WH40-200

Powyższa oferta ma charakter informacyjny i nie stanowi oferty handlowej w rozumieniu art. 66 §1 Kodeksu Cywilnego

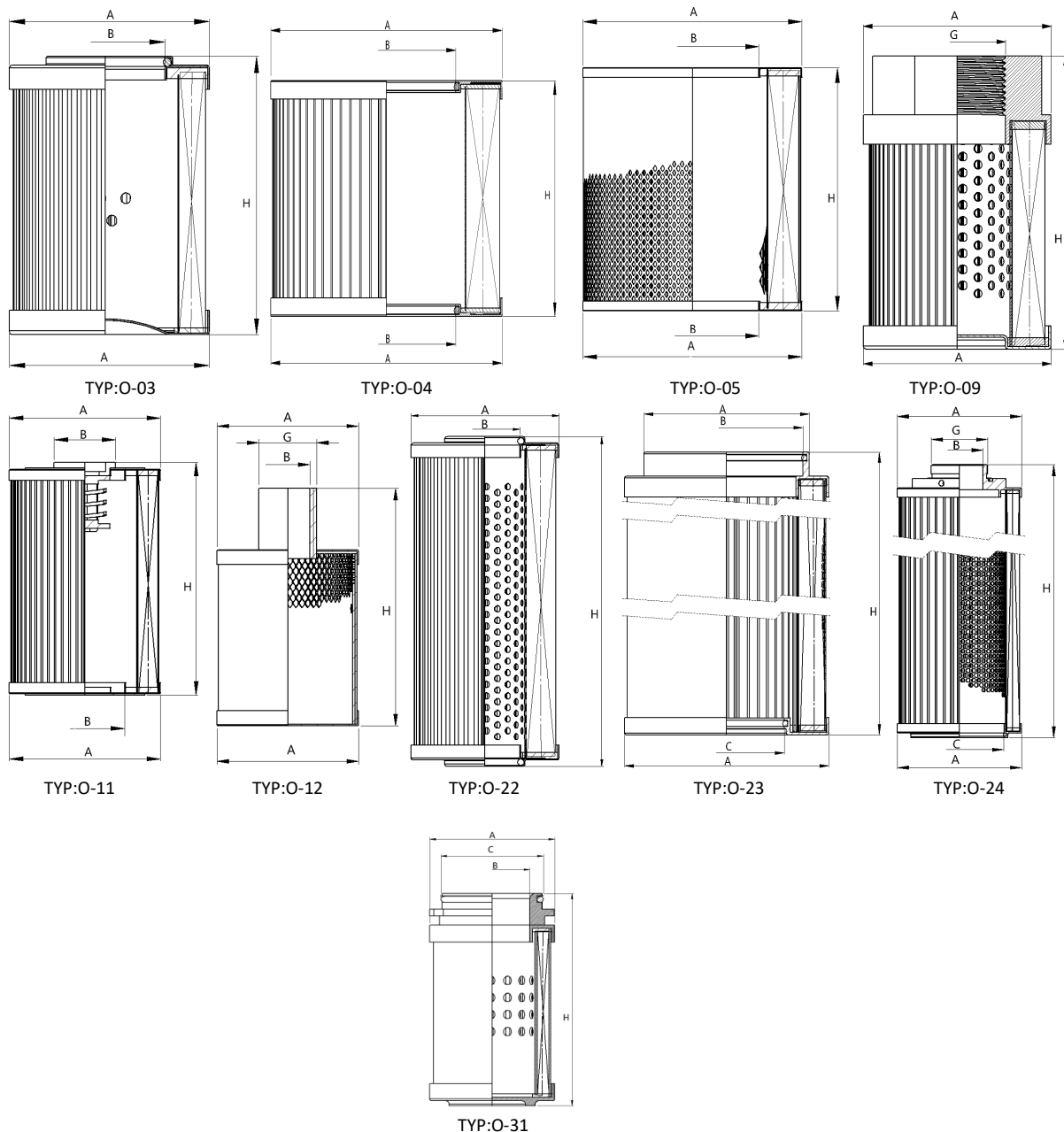

Proton Filters	Wymiary w mm					Uszczelnienie	Typ	Zamiennik
	A	B	H	G	C			
IFO-2179	111	-	262	1"	-	-	O-09	
IFO-2189	111	56	560	-	-	NBR	O-22	
IFO-2163	112	58	308	M10	-	NBR	O-15	
IFO-2191	112	34	241	-	-	NBR	O-05	WG710
IFO-2040	113	79	167	-	-	NBR	O-05	
IFO-2008	113,5	67	223	-	110	NBR	O-32	
IFO-2290	115	55	536	-	-	NBR	O-05	
IFO-2469	115	28	514	-	-	NBR	O-05	
IFO-2282	116	59	250	-	-	-	O-08	
IFO-2335	116	40	75	-	-	-	O-08	
IFO-2504	120	80	400	-	-	NBR	O-01	
IFO-2106	123,5	51	339	-	-	-	O-03	
IFO-2220	124	-	89	1 1/2"	-	-	O-09	
IFO-2241	124	104	372	-	-	-	O-05	
IFO-2479	125	-	98	1 1/2"	-	-	O-09	
IFO-2115	126	92	290	-	10,5	NBR	O-16	Donaldson P172464
IFO-2206	126	92	480	-	10,5	NBR	O-14	HF 6311(papier), R18D10C
IFO-2397	126	91	290	-	-	-	O-16	
IFO-2332	126	92	290	-	-	-	O-05	S620T120
IFO-2367	127	104	375	-	-	-	O-05	
IFO-2268	128	45	370	-	-	NBR	O-05	FRICK 531A0224H02



	Wymiary w mm					Uszczelnienie	Typ	Zamiennik
	A	B	H	G	C			
IFO-2235	129	70,3	400	-	-	NBR	O-04	XR630G25
IFO-2357	129	71	250	-	-	NBR	O-04	XR400T60
IFO-2093	130	65	260	-	-	NBR	O-03	
IFO-2257	130	57	200	-	-	NBR	O-03	
IFO-2433	130	73,3	480	-	70,9	NBR	O-23	Mahle 852690SMX10
IFO-2389	130	92	175	4"/11	-	-	O-12	
IFO-2507	130	75	500	-	-	NBR	O-22	
IFO-2197	131	-	249	2"	-	-	O-09	
IFO-2030	133	50	205	-	-	-	O-11	HD 5183
IFO-2073	133	-	538	60x1,5	95	NBR	O-24	
IFO-2305	133	64	450	-	-	NBR	O-32	
IFO-2072	134,5	91,5	474	-	76	NBR	O-23	
IFO-2029	136	51	200	-	-	-	O-11	OMT CR222R90R/04 12
IFO-2031	136	65	250	-	-	NBR	O-11	HD 4618
IFO-2000	136	91	75	-	-	-	O-05	MF61001
IFO-2326	137	96	925	-	-	NBR	O-31	

Powyższa oferta ma charakter informacyjny i nie stanowi oferty handlowej w rozumieniu art. 66 §1 Kodeksu Cywilnego

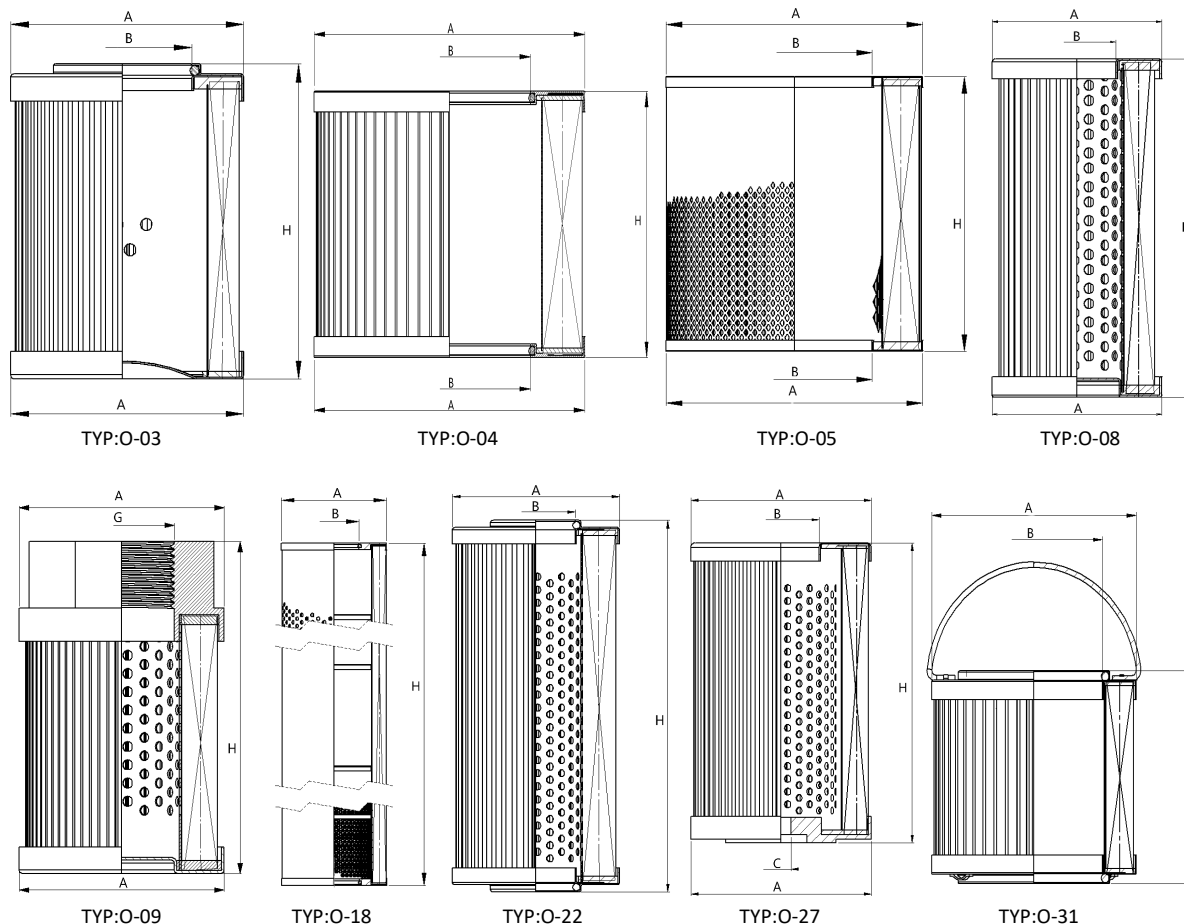

Proton Filters	Wymiary w mm					Uszczelnienie	Typ	Zamiennik
	A	B	H	C	G			
IFO-2147	139	96	242	-	-	-	O-05	
IFO-2167S	139	56	396	13,5	-	NBR	O-27	
IFO-2063	140	100	258	-	-	-	O-05	
IFO-2190	140	34	458	-	-	NBR	O-04	GEA 352199266
IFO-2248	140	95	355	-	-	-	O-05	
IFO-2434	140	65	850	-	-	-	O-05	HY 15777 Mahle 852761SMX6
IFO-2264	140	105	200	-	-	-	O-05	
IFO-2224	142	85	349	-	-	-	O-08	
IFO-2509	142	94	513	-	-	NBR	O-03	EPE 1.1401G25
IFO-2511	142	94	514	-	-	NBR	O-22	RBR 11401B25B
IFO-2130	143	96	329,4	-	-	NBR	O-31	
IFO-2043	146	70	801	-	-	NBR	O-18	
IFO-2228	146	97	444	-	-	NBR	O-03	Hydac 1300R010BN3HC
IFO-2463	146	97	483	-	-	NBR	O-03	
IFO-2464	146	97	363	-	-	NBR	O-03	DVD20030B40B
IFO-2140	148	70	356	-	-	NBR	O-05	1300 R010 BN3HC
IFO-2415	148,5	89	360	-	-	-	O-05	Tecnospark A500.
IFO-2055	150	89	203	-	-	-	O-05	
IFO-2251	150	71	530	-	-	-	O-05	
IFO-2297	150	110	450	-	-	-	O-05	
IFO-2324	150	90	366	-	-	NBR	O-05	
IFO-2363	150	90	249	-	-	NBR	O-04	SH 67502 W03AT949
IFO-2293	150	-	150	-	3"	-	O-09	STR1406SG1M250
IFO-2168	150	90	450	-	-	-	O-22	

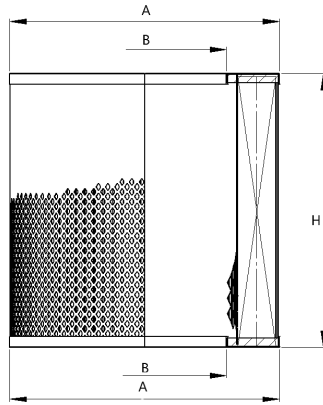

TYP:O-05

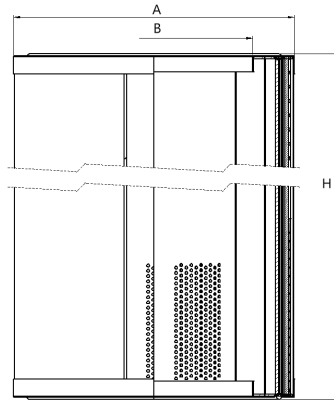

TYP:O-13

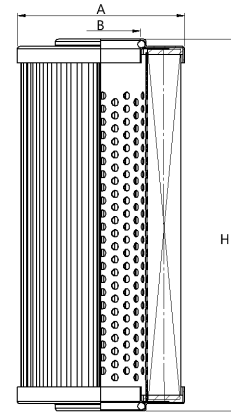

TYP:O-22

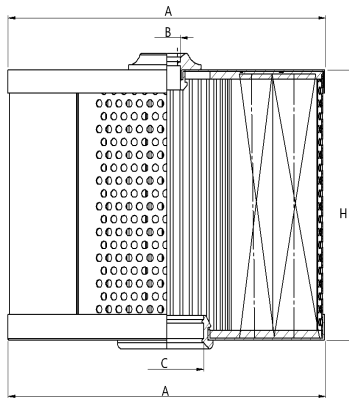

TYP:O-28

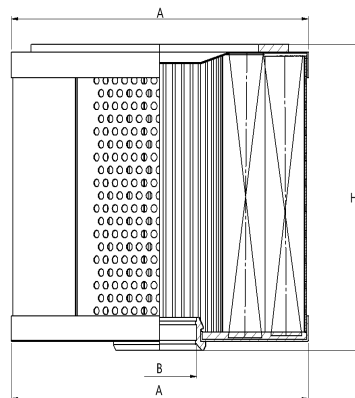

TYP:O-29

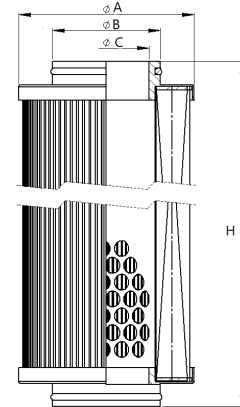

TYP:O-30

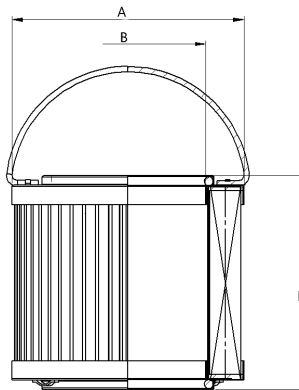

TYP:O-31

	Wymiary w mm					Uszczelnienie	Typ	Zamiennik
	A	B	H	C	G			
IFO-2045S	150	90	357	-	-	-	O-13	
IFO-2120	150	17	115	36,5	-	NBR	O-28	
IFO-2122	150	36,5	119,5	-	-	NBR	O-29	
IFO-2292	151,5	93	1056	93	-	NBR	O-30	
IFO-2101S	152	89	372	-	-	NBR	O-13	
IFO-2126	152	105	407	-	-	NBR	O-22	
IFO-2126	152	105	402	-	-	NBR	O-22	
IFO-2127	152	105	821	-	-	NBR	O-22	
IFO-2128	152	105	991	-	-	NBR	O-22	
IFO-2249	152	66	581	-	-	NBR	O-31	HY 27122/2 HY 27122/1
IFO-2105	152	40	51	-	-	-	O-05	
IFO-2110	152	88	371	-	-	NBR	O-05	

Powyzsza oferta ma charakter informacyjny i nie stanowi oferty handlowej w rozumieniu art. 66 §1 Kodeksu Cywilnego

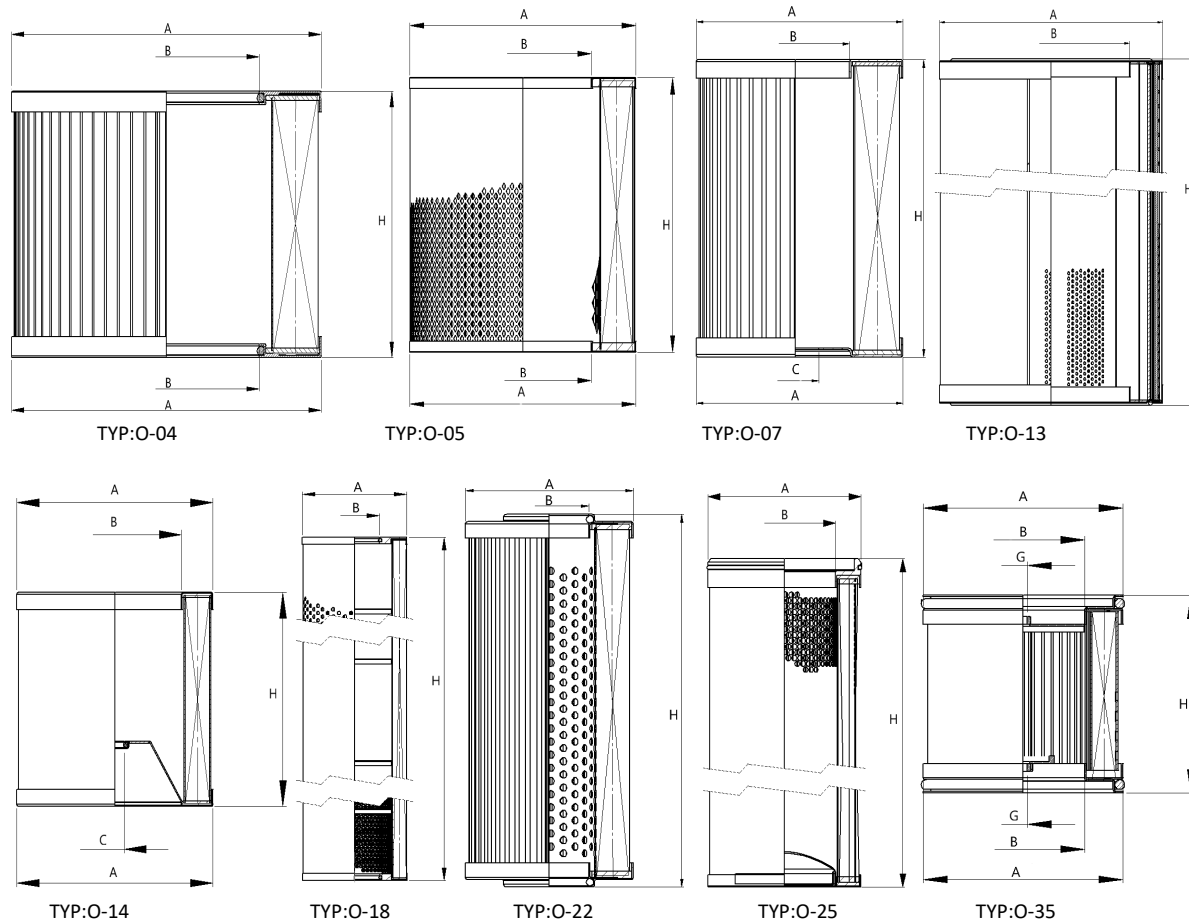

Proton Filters	Wymiary w mm					Uszczelnienie	Typ	Zamiennik
	A	B	H	C	G			
IFO-2442	152	66	445	-	-	NBR	O-05	
IFO-2111	152	88	367	-	-	NBR	O-05	
IFO-2398	152	66	457	-	-	-	O-05	
IFO-2486	152	105,5	427	-	-	NBR	O-04	SH 87026
IFO-2086	152	101	1000	-	-	NBR	O-25	PALL CS604LGH13
IFO-2104	152	50	335	40	-	-	O-07	
IFO-2176	152	100	518	-	M8	NBR	O-35	
IFO-2246	152	65	456	-	-	NBR	O-05	
IFO-2259	152	49	342	39	-	-	O-07	
IFO-2435	152	89	1000	-	-	NBR	O-13	
IFO-2010S	154	64	483	-	-	-	O-13	
IFO-2159	154	93	399	-	-	NBR	O-18	XR1000G25V / ZD25913
IFO-2136	154	93	458	-	-	NBR	O-18	ZD37336/INT 327184-25VG
IFO-2420	155	60	230	-	-	NBR	O-05	HY27248/3
IFO-2236S	159,5	120,5	1004	-	-	-	O-13	
IFO-2263S	160	54	-	-	-	NBR	O-13	
IFO-2250	160	95	392	-	-	NBR	O-22	
IFO-2438	160,5	90	400	-	-	NBR	O-04	
IFO-2328	164	112	1040	17,2	-	NBR	O-14	
IFO-2450	164	112	1040	16,2	-	NBR	O-14	
IFO-2451	164	116	545	-	-	Mikroguma	O-14	
IFO-2452	164	116	592	-	-	Mikroguma	O-14	

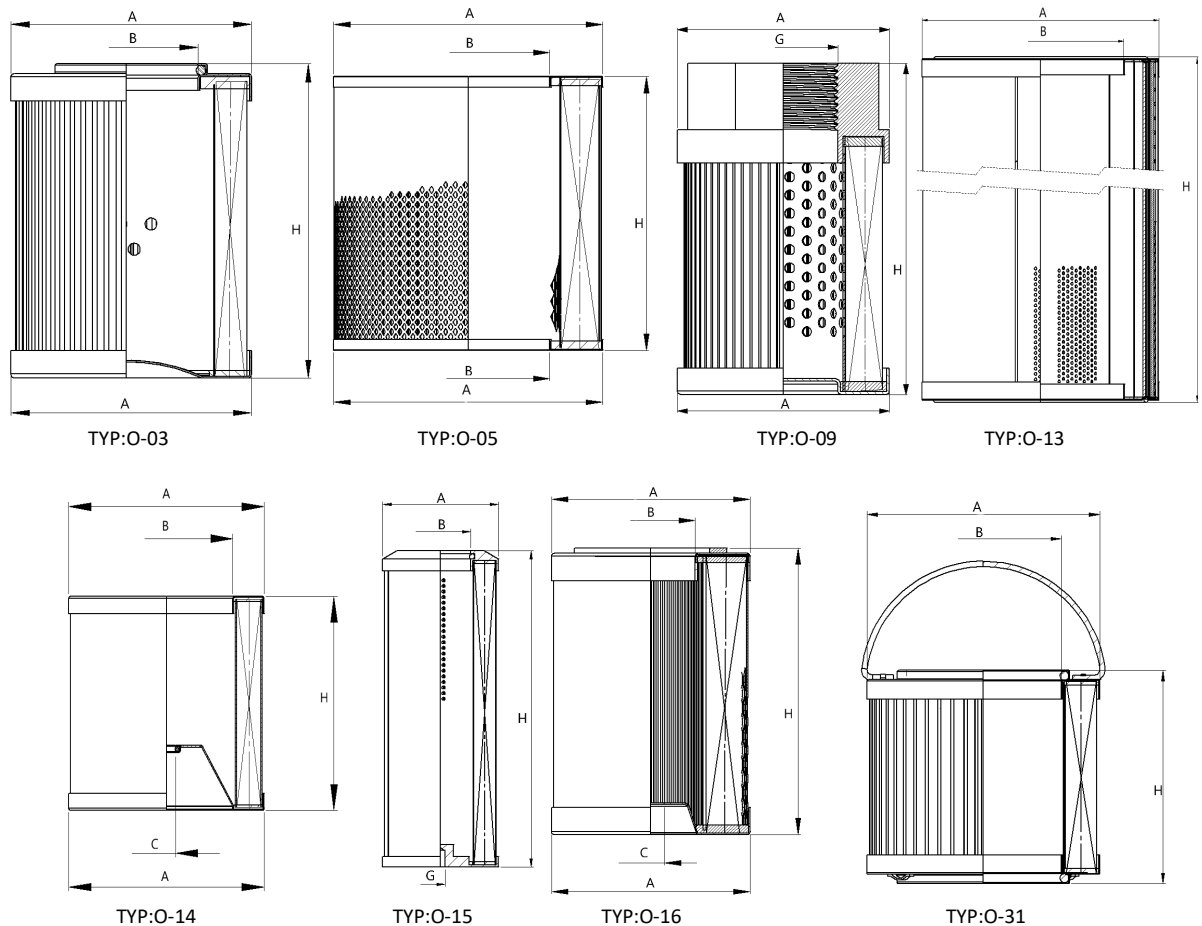

	Wymiary w mm					Uszczelnienie	TYP	Zamiennik
	A	B	H	C	G			
IFO-2388	164	112	535	-	-	NBR	O-03	
IFO-2329	164	112	1040	13	-	NBR	O-14	
IFO-2411	165	90	1000	-	-	NBR	O-13	
IFO-2183	170	90	434	-	-	NBR	O-05	GRASSO VOKES ,MCPF167DST, SO11050
IFO-2361	181	104	204	-	-	NBR	O-05	
IFO-2378	182	-	533	-	3"	-	O-09	
IFO-2302	190	130	565	-	-	-	O-05	
IFO-2362	194	118	218	-	-	NBR	O-05	
IFO-2234	195	30	360	-	-	NBR	O-05	
IFO-2193S	200	155	300	-	-	-	O-13	
IFO-2215	200	138	197	-	M16x 2	NBR	O-15	
IFO-2416	200	146	155	-	-	-	O-05	
IFO-2404	200	188	480	-	-	-	O-16	
IFO-2173	223	166	1200	171	-	NBR	O-31	
IFO-2319	228	181	562	-	-	NBR	O-05	
IFO-2109S	239	180	867	-	-	-	O-13	FRICK 531B0099H01
IFO-2342S	239	180	420	-	-	NBR	O-13	SF SAO60011
IFO-2369	242	132	243	-	-	-	O-05	
IFO-2356S	245	153	246	-	-	NBR	O-13	
IFO-2280	250	160	400	-	-	-	O-05	
IFO-2116S	251	177	418	180	-	NBR	O-13	

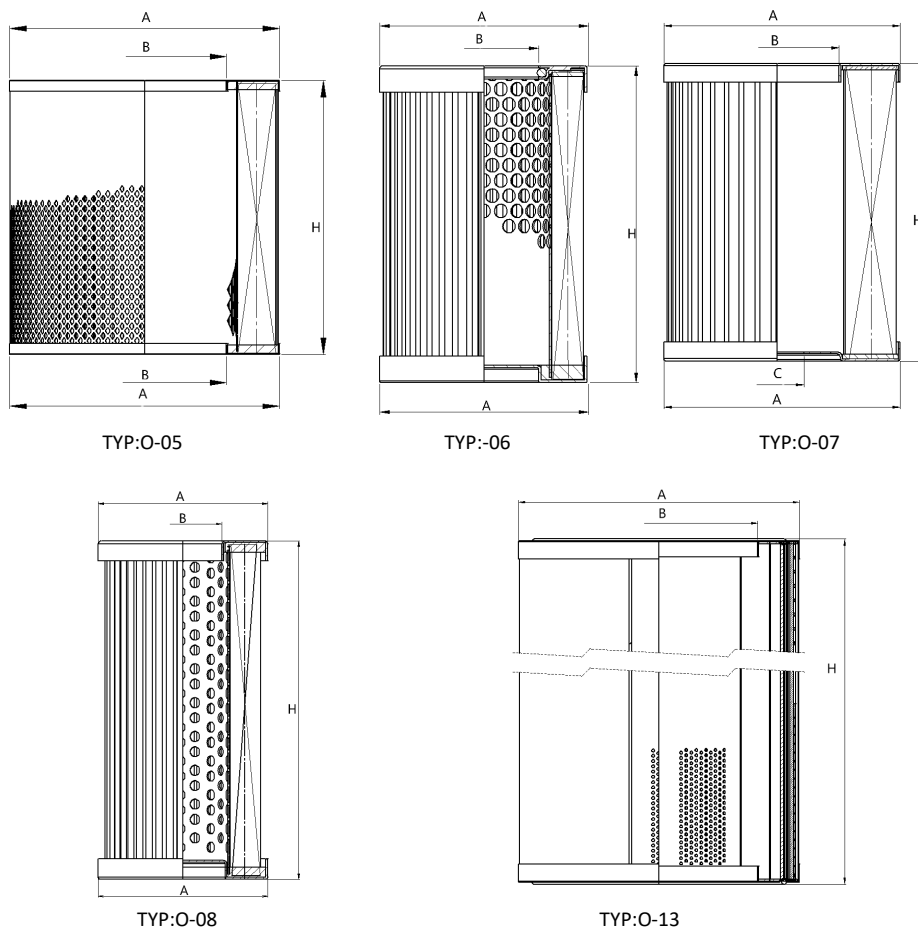

	Wymiary w mm					Uszczelnienie	TYP	Zamiennik
	A	B	H	C	G			
IFO-2330	254	120	296,5	13,5	-	-	O-07	
IFO-2304	255	98	245	-	-	NBR	O-05	
IFO-2322S	255	193	233	-	-	NBR	O-13	
IFO-2399	265	54	267	-	-	NBR	O-05	
IFO-2360	274	195	303	-	-	NBR	O-05	
IFO-2013S	292	205	761	-	-	-	O-13	
IFO-2202S	300	200	535	-	-	NBR	O-13	
IFO-2203SGF	300	200	535	-	-	NBR	O-13	
IFO-2439	315	40	115	-	-	NBR	O-06	
IFO-2408	330	104	465	-	-	-	O-05	
IFO-2350S	370	230	370	-	-	NBR	O-05	SOLBERG 377P
IFO-2283	402	396	555	39	-	-	O-08	
IFO-2195S	453	360	511	-	-	NBR	O-13	
IFO-2403S	484	378	508	-	-	NBR	O-13	